

# MOD HUB Series

*A Line of Modular Active Hubs for ARCNET®  
Local Area Networks*

---

## User Manual

#TD401600-0MO

**CONTEMPORARY** CONTROLS®

---

## Trademarks

Contemporary Controls, ARC Control, ARC DETECT and EXTEND-A-BUS are trademarks or registered trademarks of Contemporary Control Systems, Inc. ARCNET is a registered trademark of Datapoint Corporation. Other product names may be trademarks or registered trademarks of their respective companies.  
TD401600-0MO Revised November 2010

## Copyright

© Copyright June 1996–2010 by Contemporary Control Systems, Inc. All rights reserved. No part of this publication may be reproduced, transmitted, transcribed, stored in a retrieval system, or translated into any language or computer language, in any form or by any means, electronic, mechanical, magnetic, optical, chemical, manual, or otherwise, without the prior written permission of:

Contemporary Control Systems, Inc.  
2431 Curtiss Street  
Downers Grove, Illinois 60515 USA  
Tel: +1-630-963-7070  
Fax: +1-630-963-0109  
E-mail: [info@ccontrols.com](mailto:info@ccontrols.com)  
WWW: <http://www.ccontrols.com>

Contemporary Controls Ltd  
14 Bow Court  
Fletchworth Gate  
Coventry CV5 6SP UK  
Tel: +44 (0)24 7641 3786  
Fax: +44 (0)24 7641 3923  
E-mail: [ccl.info@ccontrols.com](mailto:ccl.info@ccontrols.com)

## Disclaimer

Contemporary Control Systems, Inc. reserves the right to make changes in the specifications of the product described within this manual at any time without notice and without obligation of Contemporary Control Systems, Inc. to notify any person of such revision or change.

# Contents

---

<b>Chapter 1</b>	<b>Introduction .....</b>	<b>1</b>
	1.1 Description .....	1
	1.2 Benefits .....	2
	1.3 Specifications .....	2
	1.4 Regulatory Compliance .....	4
	1.5 Power Requirements .....	4
	1.6 Ordering Information .....	4
<b>Chapter 2</b>	<b>Installation .....</b>	<b>6</b>
	2.1 Introduction .....	6
	2.2 Electromagnetic Compliance .....	6
	2.3 Flange Mounting .....	7
	2.4 MTG-RAK — Rack Mounting Kit .....	7
	2.5 Connecting Cables to the MOD HUB .....	8
	2.6 Turning the Active HUB “ON” .....	16
	2.7 Ensuring Proper HUB Operation .....	17
	2.8 Troubleshooting Tips .....	17
	2.9 Isolating Faulty Nodes with Line Activity Indicators .....	19
	2.10 Supporting Extended Timeouts .....	20
<b>Chapter 3</b>	<b>Operation .....</b>	<b>22</b>
	3.1 Theory of Operation .....	22
<b>Chapter 4</b>	<b>Service .....</b>	<b>24</b>
	Technical Support .....	24
	Warranty .....	24
	Returning Product for Repair .....	24
	Declaration of Conformity .....	24

---

## Appendix

Permissible Segment Lengths .....	25
-----------------------------------	----

### List of Figures

Figure 2-1	EIA-485 Daughterboards .....	13
Figure 2-2	Each -485 hub port has provisions for applying bias and termination. Make sure common mode voltage ( $V_{cm}$ ) does not exceed $\pm 7$ Vdc .....	14
Figure 2-3	AC Coupled EIA-485 Option (-485X) .....	15
Figure 2-4	Front Panel of the MOD HUB Shown Fully Loaded .....	16
Figure 2-5	The extended timeout settings only affect the RECON light with no affect to the hub operation .....	21

# 1 Introduction

---

## 1.1 Description

The MOD HUB series of modular active hubs provides a convenient and flexible method of expanding ARCNET local area networks. EXP expansion modules are installed into the MOD HUB that support the particular cabling technology desired. The MOD HUB is available with either four expansion slots or twelve. Since most expansion modules support four ports each, a total of 48 ports can be provided within one hub. MOD HUBs can be cascaded via an expansion port on each hub to expand the network to the limit of the ARCNET technology.

The MOD HUB is provided with an integral universal voltage power supply, four or sixteen slot card cage and internal timing module permanently installed into the hub's backplane. There are no expansion modules provided with the MOD HUB. The timing module uses a precision delay line timing generator which regenerates the incoming ARCNET signal without introducing excessive bit jitter. The regenerated signal is then sent to all other ports on the hub. A watchdog timer is included to prevent the possibility of hub lockup eliminating the necessity of cycling power on a failed hub. The hub unlatch delay time is derived from a crystal oscillator for high accuracy and repeatability.

Active hubs increase the robustness of ARCNET networks. They maximize the distance that can be achieved on each cable segment — up to 2000 feet on coaxial segments. They prevent interference to the network by squelching reflections caused by open or shorted cable segments attached to the hub. Unused hub ports need not be terminated. Active hubs allow for a distributed star topology, thereby minimizing the cabling required in a plant.

---

There are several LED indicators that assist in troubleshooting the network. One LED indicator informs if the network has undergone a reconfiguration. Another indicator senses if the hub is properly generating internal hub signals. There are separate LEDs that monitor the two internal power supplies.

## **1.2 Benefits**

- Compatible with the baseband ARCNET network
- Compatible with all Contemporary Controls' (CC) network interface modules (NIMs)
- Supports up to 48 ports in four-port increments
- Two sizes of enclosures: 16 and 48 ports
- Offers easy expansion with plug-in modules
- Mixes coaxial, twisted-pair and glass fiber optic cable in one hub
- Isolates network faults with diagnostic LEDs
- LED indicator identifies reconfiguration of the network
- Minimizes hub jitter with precision delay line timing
- Activity LEDs for each port
- Provision for rack mounting
- Watch-dog timer prevents hub lockup
- Hub unlatch delay digitally controlled

## **1.3 Specifications**

### Mechanical

See diagrams on page 3.

---

## Environmental

Operating temperature: 0°C to +60°C

Storage temperature: -40°C to +85°C

## Functional

Hub delay: 320 ns (typ)

Unlatch delay time: 5.9 μs (typ)

Extended timeouts: Supports all three extended ARCNET timeouts.

Signalling rate: 2.5 Mbps nominal

Compliance: ANSI/ATA 878.1

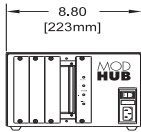

**MODHUB-16, 16E**

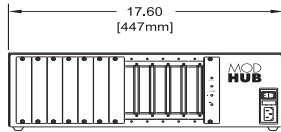

**MODHUB-48, 48E**

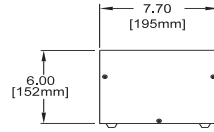

**SIDE VIEW**

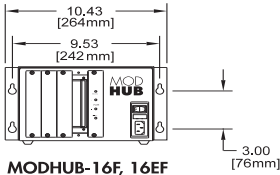

**MODHUB-16F, 16EF**

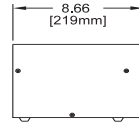

**SIDE VIEW**

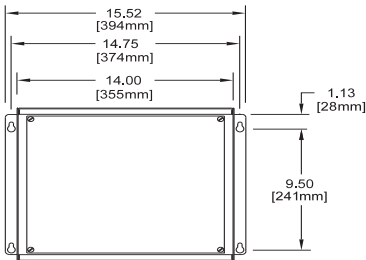

**MODHUB-16F-N**

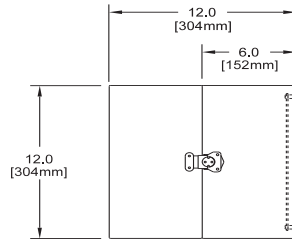

**SIDE VIEW**

---

## 1.4 Regulatory Compliance

UL 1950 listed  
cUL listed per CSA 22.2 No. 950-95  
IEC 950 classified  
CFR 47, Part 15 Class A  
CE Mark

## 1.5 Power Requirements

### Electrical

	<u>MODHUB-16 series</u>	<u>MODHUB-48 series</u>
Input voltage:	100 VAC to 230 VAC (+/-10%)	100 VAC to 230 VAC (+/-10%)
Input current:	0.5 amps max	1.0 amps max
Input frequency:	47 Hz to 63 Hz	47 Hz to 63 Hz
Input fuse(s):	1 amp slo blo 5 mm x 20 mm	1 amp slo blo 5 mm x 20 mm

## 1.6 Ordering Information

Select an adequately sized MOD HUB for the number of ports required. The MODHUB-16 has four slots and can support up to 16 ports. The MODHUB-48 has twelve slots and can support up to 48 ports. EXP expansion modules generally support four ports each and are ordered separately. Refer to EXP data sheets for detailed information.

MOD HUB “E” designation means export model and is shipped with a continental Europe power cord. These units have two input fuses to address unpolarized power systems and carry the CE Mark. This model can be modified at the factory for single fuse operation if requested.

MOD HUB “F” designation means flange-mounted enclosure which is standard for panel-board mounting. For rack mounting, do not specify the “F” designation, but order a MTG-RAK instead. The MTG-RAK supports either two MODHUB-16s (-16Es) or one MODHUB-48.



---

MODHUB-16F-N designation means that a version of the MODHUB-16F (with vented cover) is installed into a NEMA 1 enclosure. A duplex receptacle is provided inside the NEMA 1 enclosure. This receptacle must be wired via a conduit connection from an appropriate power source.

<u>Model</u>	<u>Description</u>
MODHUB-16	16-pt. powered card cage (120V 50/60 Hz)
MODHUB-16E	16-pt. powered card cage (230V 50/60 Hz)
MODHUB-16F	16-pt. powered card cage flange mounted (120V 50/60 Hz)
MODHUB-16EF	16-pt. powered card cage flange mounted (230V 50/60 Hz)
MODHUB-16F-N	16-pt. powered card cage flange mounted NEMA 1 enclosure (120V 50/60 Hz)
MODHUB-48	48-pt. powered card cage (120V 50/60 Hz)
MODHUB-48E	48-pt. powered card cage (230V 50/60 Hz))
MTG-RAK	MODHUB rack-mounting kit

# 2 Installation

---

## 2.1 Introduction

The MOD HUB can be either desktop mounted, panel mounted or rack mounted. One model, the MODHUB-16F-N has its own NEMA 1 enclosure for wall mounting.

## 2.2 Electromagnetic Compliance

The MOD HUB series complies with Class A radiated and conducted emissions as defined by CFR 47 Part 15 and EN55022. This equipment is intended for use in nonresidential areas. Refer to the following notices in regard to the location of the installed equipment.

**Note:** This equipment has been tested and found to comply with the limits for a Class A digital device, pursuant to Part 15 of the CFR Rules. These limits are designed to provide reasonable protection against harmful interference when the equipment is operated in a commercial environment. This equipment generates, uses, and can radiate radio frequency energy and, if not installed and used in accordance with the instruction manual, may cause harmful interference to radio communications. Operation of this equipment in a residential area is likely to cause harmful interference in which case the user will be required to correct the interference at his own expense.

### **Warning**

This is a Class A product as defined in EN55022. In a domestic environment this product may cause radio interference in which case the user may be required to take adequate measures.

---

The MOD HUB has been tested to EN55024 Generic Immunity Standard—Industrial Environment. This standard identifies a series of tests requiring the equipment to perform to a particular level during or after the execution of the tests. The three classes of performance are defined by CC as follows:

Class A — Normal operation, however, occasional reconfigurations may occur or throughput reduced due to error recovery algorithm by the ARCNET data link level protocol.

Class B — Throughput reduced to zero and continuous reconfigurations occur. Normal operation resumed after offending signal removed.

Class C — Complete loss of function. Unit resets and normal operation restored without human intervention.

At no time did the MOD HUB fail to return to normal operation or become unsafe during the execution of these tests.

A copy of the Declaration of Conformity is in the appendix.

## **2.3 Flange Mounting**

The MODHUB-16 is also available in a flange mount (MODHUB-16F) for mounting to a panel board or subpanel. Make sure the MODHUB-16F flanges are mounted onto a vertical surface to ensure proper airflow to the MOD HUB. If desired, the four mounting feet located at the bottom of the enclosure can be removed using a small screwdriver.

## **2.4 MTG-RAK — Rack Mounting Kit**

Both the MODHUB-16 and MODHUB-48 can be installed in standard EIA 19" racks using the MTG-RAK rack mounting kit occupying 7" of vertical rack space. Either one MODHUB-16 (16E), two MODHUB-16s (16Es) side-by-side, or one MODHUB-48 can be mounted using one rack mounting kit. To install the MOD HUBs to the shelf provided with this kit, simply remove the four rubber feet and attach the MOD HUB directly to the shelf using the screws from the rubber feet. Be

---

careful that the complete rack does not become unstable due to the increased mechanical load.

The height of the MTG-RAK exceeds the height of the MOD HUB to ensure that air flow will still be maintained through the MOD HUB when 19" equipment is stacked vertically with no voids. Still it is important to check that the MOD HUB does not experience an increase in its ambient temperature that exceeds its specified rating of 60°C.

Ensure that there is adequate power service for the MOD HUB and that circuit overloading is not introduced with the addition of the MOD HUB. This is especially important when power strips are used in mounting racks. Make sure that earthing (ground connection) is maintained to the MOD HUB through any power strip.

## **2.5 Connecting Cables to the MOD HUB**

The MOD HUB is shipped without EXP expansion modules. Select the appropriate expansion modules for the cable type and distance desired. Refer to the individual expansion module installation instructions for information on installing the modules. More information on designing an ARCNET cabling system can be found in CC's publication "*ARCNET Tutorial & Product Guide.*"

Attach the coaxial, twisted-pair or fiber optic cables to the devices that are being networked in the ARCNET LAN (refer to Appendix A to verify that maximum cabling distance specifications are not exceeded).

### *2.5.1 Connecting Coaxial Cable Star Networks (-CXS)*

There are generally two types of coaxial cables that are used with ARCNET, RG-59/u and RG-62/u. RG-59/u is 75-ohm cable which does not precisely match the impedance of the transceivers used on the MOD HUB expansion modules. This cable will work, but communication distances are reduced compared to RG-62/u because of the higher attenuation of

---

RG-59/u cable. We recommend RG-62/u because it is a better match to the transceivers and a full 2000 foot segment distance can be achieved using this cable. Both cables support male BNC connectors which the -CXS expansion module accommodates.

### 2.5.2 *Connecting Coaxial Cable Bus Networks (-CXB)*

There is no expansion module for a bus transceiver (-CXB); however, bus topology is supported with the MOD HUB. In a bus configuration, one end of the segment terminates into a -CXS expansion module **without** a passive terminator. However, the other end of the bus segment is terminated **with** a passive terminator. Be sure to use the proper passive terminator, 93 ohms for RG-62/u and 75 ohms for RG-59/u. Do not attach the -CXS expansion module in the middle of a bus segment using a BNC "T" connector. However, the same effect can be accomplished by splitting the bus segment into two pieces, each of which attaches to a -CXS port. Again, no passive termination needs to be applied to the hub side of a bus segment.

### 2.5.3 *Connecting Twisted-Pair Star Networks (-TPS)*

Each -TPS port is constructed as a -CXS port with an internal BALUN transformer. A BALUN (which is an acronym for BALANCED-UNbalanced) connects the single-ended -CXS transceiver to a balanced transceiver suitable for driving balanced twisted-pair cabling. The internal BALUN in the -TPS port is compatible in wiring to an external MUX LAB's part number 10070 BALUN. Therefore, a -TPS port can directly connect to another -TPS port on either a hub or a NIM or connect to an external BALUN attached to a -CXS port. In both cases use straight-through twisted-pair cable with RJ-11 connectors. Straight-through cable provides a one to one correspondence in cable connections at both ends. Straight-through cable can be identified as follows. Take both connectors from a cable length and lay them side by side with the locking clip facing the same direction. The wire color present on the left-most side of one connector must be the same color on the

---

left-most side of the other connector. This is a straight-through cable which is used exclusively to connect -TPS ports. If the cable color on the left side of a connector appears on the right side of the other connector, this inverted cable will result in operational problems with your twisted-pair network.

#### *2.5.4 Connecting Twisted-Pair Bus Networks (-TPB)*

The -TPS transceivers use internal BALUNs and, therefore, are not directly compatible with twisted-pair bus networks. All -TPS systems must be tied in either a star (one hub and multiple NIMs) or distributed star (multiple hubs and multiple NIMs) topology. Under no circumstances should more than two -TPS ports be connected to the same cable. However, a -TPS port can terminate the ends of a -TPB network. Connect one end of the bus segment to a -TPS port **without** passive termination. Do not attach a -TPS port to the middle of the bus segment. It will be necessary to invert the wiring sense at the -TPS port since the -TPS port has inverted polarity to a -TPB port (BALUNs introduce a signal inversion).

#### *2.5.5 Connecting Fiber Optic Cable (-FOG), (-FG3)*

Single mode fiber optic cable is available in one size and multimode fiber optic cable is typically available in three sizes, 50/125, 62.5/125, and 100/140. The larger the size, the more energy that can be launched and, therefore, the greater the distance. Two connectors are supported — the SMA and the ST. The conventional SMA connector offers a threaded termination. When this type of connection is tightened excessively, the fiber optic cable can break resulting in unreliable communications. Also, the degree of tightening affects the optimum throughput of the cable. Depending upon the degree of tightening, fiber alignment can vary from the optimal coupling, thereby introducing some attenuation. The ST connector alleviates both of these problems but is generally more expensive than the SMA connector. The ST provides a bayonet style connector similar in operation to a BNC coaxial cable connector.

---

Fiber optic connections require a duplex cable arrangement. Two unidirectional cable paths provide the duplex link. There are two devices at each port on the MOD HUB expansion module. One device, colored light gray, is the transmitter and the other, dark gray, is the receiver. Remember that “light goes out of the light (gray).” To establish a working link between a hub and a network interface module or a hub to another hub, the transmitter of point A must be connected to a receiver at point B. Correspondingly the receiver at point A must be connected to a transmitter at point B. This establishes the duplex link which is actually two simplex links. Fiber optic cable is available paired for this purpose.

Usually the manufacturers’ labeling is only on one cable of the pair which is handy for identifying which of the two cables is which. Establish your own protocol for connecting cable between hubs and NIMs in the field using the manufacturers’ labeling as a guide. But remember that to connect point A to point B requires a paired fiber optic cable and that the light gray connector at one point must connect to a dark gray connector at the other point.

#### *2.5.6 Connecting DC-Coupled EIA-485 Networks*

One RJ-11 connector is provided for each DC-coupled EIA-485 segment. This segment can be up to 900 feet long of IBM Type 3 unshielded twisted-pair cable, and as many as 17 nodes can occupy the segment. Make sure that the phase integrity of the wiring remains in tact. Pin 3 of the modular jack on each NIM and hub port must be connected together. The same applies to pin 4. Most modular (satin cable) telephone wiring flips the phase of the wiring thereby reversing the connections to pins 3 and 4 at each end. Do not use this type of cable. Some modular cable is not even twisted. Be sure to use the proper cable.

---

## *Termination*

Each end of the segment must be terminated in the characteristic impedance of the cable. A 120-ohm resistor can be invoked with a jumper which resides on the EIA-485 daughterboard adjacent to the RJ-11 connector on the expansion module. With the middle jumper inserted at location E1 on the daughterboard, 120 ohms of resistance is applied across the twisted-pair. With the jumper removed, no termination is applied. If it is desired to apply external termination instead, remove this jumper and insert an RJ-11 style tap (not provided) and terminator in the RJ-11 port.

## *Bias*

In addition to the termination, it is also necessary to apply bias to the twisted-pair network so that when the line is floated differential receivers will not assume an invalid logic state. There are two precision bias resistors ( $R_b$ ) of equal value on each daughterboard. One resistor is tied to the +5 V line while the other is tied to ground. Each resistor has a jumper associated with it. If the two jumpers are installed, the resistor tied to +5 V is connected to the (+) signal line while the grounded resistor is connected to the (–) line. This voltage drop will bias the differential receivers into a defined state when no differential drivers are enabled. Differential receivers typically switch at or near zero volts differential and are guaranteed to switch at  $\pm 200$  mV. Through the transition point, 70 mV of hysteresis will be experienced. Therefore, a positive bias of 200 mV or greater will ensure a defined state. We recommend that bias be applied to both ends of the wiring segment by installing the two end jumpers located at position E1 on the daughterboard. This is to be done for only the hub ports or NIMs located at the ends of the segment. All other NIMs will have their jumpers removed.

The termination and bias rules are simple. If the NIM or hub port is located at the extreme ends of the segment, install all three jumpers at location E1 on the daughterboard. If the NIM is located between the two end NIMs or hub ports, remove all three jumpers. If external termination is desired, remove the middle jumper at E1 and provide the external termination.



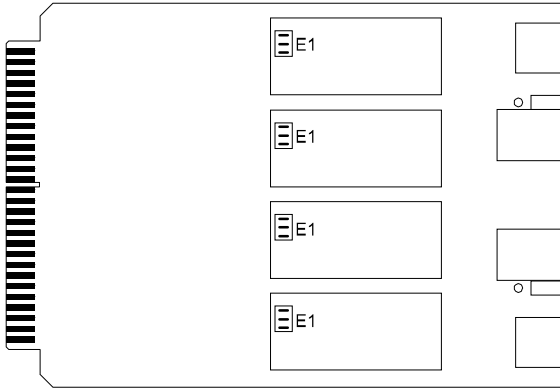

*Figure 2-1. EIA-485 Daughterboards*

For EIA-485 DC operation, it is very important that all devices on the wiring segment be referenced to the same ground potential in order that the common mode voltage requirement ( $\pm 7$  Vdc) of the EIA-485 specification is achieved. This can be accomplished by running a separate ground wire between all hubs and computers or by relying upon the third wire ground of the power connector assuming that the DC power return is connected to chassis ground on all computers (this is the case with the MOD HUB). Another approach would be to connect the DC common of each computer to a cold water pipe. Connected systems, each with different elevated grounds, can cause unreliable communications or damage to the EIA-485 differential drivers. Therefore, it is important that an adequate grounding method be implemented.

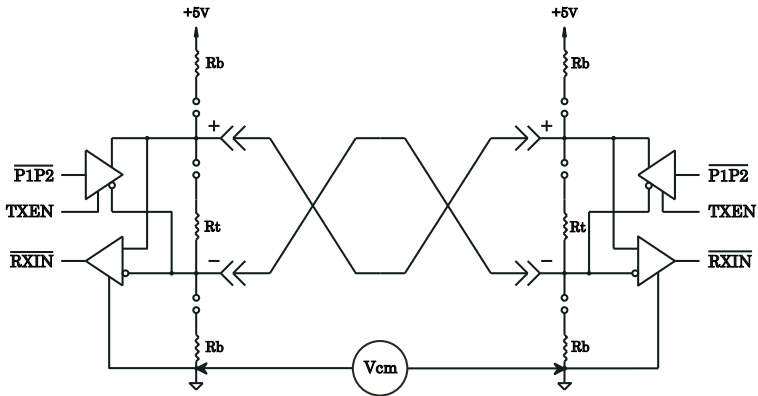

*Figure 2-2. Each -485 hub port has provisions for applying bias and termination. Make sure common mode voltage ( $V_{cm}$ ) does not exceed  $\pm 7$  Vdc.*

Segments of -485 (-485D) connected NIMs can be extended through the use of active hubs. Select a MOD HUB expansion module with a -485 compatible port. Connect one end of the segment to this port following the same termination rules as used for a NIM. This hub port counts as one NIM when cable loading is being calculated. The NIM electrically closest to the hub port should not have any termination or bias applied. Follow the same rules for other segments attached to different hub ports. Each hub effectively extends the segment another 900 feet. Maintain the same cabling polarity as the NIMs by using cable connections that do not invert the signals.

### 2.5.7 Connecting AC-Coupled EIA-485 Networks

The AC-coupled EIA-485 transceiver offers advantages over the DC-coupled EIA-485. No bias adjustments need to be made since each transceiver has its own fixed bias network isolated by a pulse transformer. Unlike the DC-coupled EIA-485, wiring polarity is unimportant. Either inverted or straight through cable can be used or even mixed within one AC-coupled network. Much higher common mode voltage levels can be achieved with

---

AC coupling due to the transformer coupling which has a 1000 Vdc breakdown rating.

There are disadvantages to the AC-coupled transceiver as compared to the DC-coupled technology. The DC-coupled distances are longer (900 feet) compared to the AC-coupled distance (700 feet).

The cabling rules of the -485X are similar to the -485. Wire a maximum of 13 NIMs (reduce by one for each hub port) in a daisy-chain fashion leaving the end devices as either NIMs or hub ports. On these NIMs or hub ports insert a jumper at E1 on both -485X daughterboards to invoke 120-ohm termination resistors or leave the jumpers open and insert RJ-11 style passive terminators. In the case of a hub port, an RJ-11 style tap is required. Termination should not be applied to any of the NIMs located between the two end NIMs or hub ports of the segment. Do not mix -485 (-485D) and -485X NIMs together on one segment; however, bridging of the technologies is possible using two appropriate expansion ports on the MOD HUB. To extend -485X segments, use a hub as discussed under the -485 section. Cable inversion is not of any consequence.

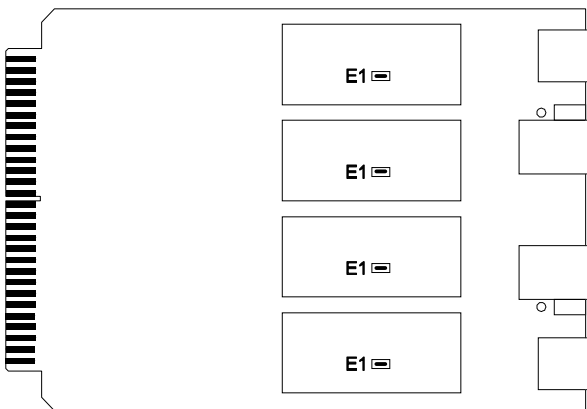

*Figure 2-3. AC Coupled EIA-485 Option (-485X)*

WIRING CHART RJ-11 CONNECTOR			
PIN	-TPS	-485	-485X
1	—	—	—
2	N/C	N/C	N/C
3	+SIG	–SIG	SIG
4	–SIG	+SIG	SIG
5	N/C	N/C	N/C
6	—	—	—

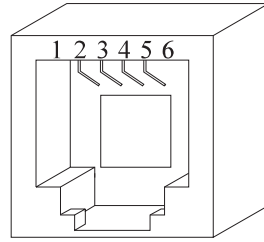

## 2.6 Turning the Active HUB “ON”

Turn the MOD HUB unit on by depressing the Power switch located on the lower right of the MOD HUB’s front panel.

**Note:** Once your MOD HUB is on, we recommend that it be left on unless you are installing/removing modules to/from the MOD HUB. Connecting/ disconnecting cables with the hub on will cause no damage to the MOD HUB.

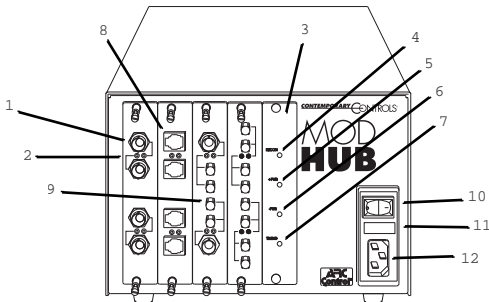

- |                                    |                           |
|------------------------------------|---------------------------|
| 1. BNC Connector                   | 7. Timing Indicator       |
| 2. Port Activity Indicator         | 8. RJ-11 Connector        |
| 3. Timing Module                   | 9. ST or SMA Connector    |
| 4. Reconfiguration Indicator       | 10. Power Switch          |
| 5. Power Supply Indicator for +Pwr | 11. Fuse Box              |
| 6. Power Supply Indicator for –Pwr | 12. Power Cord Receptacle |

*Figure 2-4. Front Panel of the MOD HUB Shown Fully Loaded*

---

## 2.7 Ensuring Proper HUB Operation

Check each port's line activity indicator. All indicators on the front panel of the active hub should light up when the hub is turned on, assuming the cables connected to the hub are also connected at the other end to ARCNET network interface modules or active hubs. Please note that the RECON indicator, in the right-most location on the front panel, will only flash for a second when the hub is powered on or when reconfigurations occur on the network. The other three indicator lights located in line with the RECON indicator, specifically the +PWR, -PWR and TIMING indicators, should always be lit when the hub is on and operating properly. Additionally, the activity indicator for each port should be lit if a cable is connected to that port and the device at the opposite end of the cable is on. Refer to the next section covering troubleshooting tips if normal hub operation is not observed.

## 2.8 Troubleshooting Tips

If one of the devices in your ARCNET LAN loses its communications capabilities after the MOD HUB has been installed and used, first check the four indicator lights on the timing module, the right-most module on the front panel of the MOD HUB unit.

**Note: Whenever any problems occur with the MOD HUB unit, carefully document exactly what happened and what steps you took to handle the problem. This will assist us in helping you solve the problem.**

### 2.8.1 Timing Module Indicators

**+PWR** This indicator should be lit when the MOD HUB is powered. The internal positive DC power is continually monitored to verify that this voltage is within specification. If this indicator is not lit when the hub is turned on, there is a problem with the internal positive power supply.

---

**–PWR** This LED should also be lit when the MOD HUB is powered. This LED monitors the internal negative DC power to ensure that it is operating within an acceptable power range. If this indicator is not lit when the hub is turned on, there is a problem with the internal negative power supply.

If neither the +PWR nor the –PWR indicators light when the MOD HUB is turned on, check for a blown fuse in the MOD HUB.

To open the fuse box on the front panel of the MOD HUB (domestic models only):

**Turn off the MOD HUB by depressing the power switch located on the right side of the front panel of the MOD HUB. Unplug the power cord from the power receptacle on the front panel of the MOD HUB.**

Locate the fuse box (between the power switch and the power receptacle on the front panel of the hub). Gently place the wide edge of a screwdriver beneath the fuse box cover and lift to dislodge the cover.

Lift out the fuse attached to the fuse box cover and check the fuse. The fuse is blown if the wire in the fuse is broken.

If the fuse is blown, replace it with the spare 5 mm x 20 mm fuse located in the fuse box cover, and then close the fuse box, reattach the power cord, and turn on the MOD HUB.

If, after replacing the fuse, the +PWR and –PWR indicators still do not light up when the hub is turned on, call technical support.

**Note: Export models do not have spare fuses. Both fuses in the fuse holder are actively used.**

**TIMING** If no cables are connected to the MOD HUB or if no valid ARCNET activity is present on any one port on the MOD HUB, this indicator is off. If ARCNET activity is present and the internal regeneration of the ARCNET signal is proper, this indicator will light, telling you that the MOD HUB is receiving ARCNET signals and (faithfully) reproducing these

---

signals to other ports on the MOD HUB. If this indicator does not light when activity is present on any hub port, as it should, then the timing module is defective.

**RECON** Reconfigurations of the network routinely occur as nodes are added to the network and pose no problem to the network. When they occur, this LED will flash on for one second to facilitate viewing even though the reconfiguration process takes a fraction of a second. However, frequent reconfigurations can degrade performance of the network as indicated by this LED flashing repeatedly or lighting continuously. If this is occurring on your MOD HUB, you need to isolate the connected computers to find out which node is causing these reconfigurations.

The cause of frequent reconfigurations could be a faulty network interface module, defective cable, duplicate node IDs, or a high incidence of electrical interference. An occasional flash of this light is normal as automatic reconfigurations are a feature of ARCNET. If this is all that is viewed, you can feel well assured that the network is operating properly.

## **2.9 Isolating Faulty Nodes with Line Activity Indicators**

In addition to the four indicators on the timing module, each port on each expansion module has a line activity indicator. Each line activity indicator lights whenever the corresponding port on the MOD HUB receives ARCNET signals. The intensity of these indicator lights changes with the amount of activity and this is how defective nodes can be isolated.

The worst possible occurrence is the “chattering node.” A chattering node generates reconfigurations continuously, as evidenced by the RECON light being continuously lit, because this node has a defective receiver on its network interface module. Under these circumstances, the line activity indicator that corresponds to the port on the expansion module connected to the chattering node will light brightly while all other line activity indicators will appear dim. Disconnecting this cable

---

from the MOD HUB will extinguish the RECON indicator and return all other port activity lights to equal brightness, thereby isolating the defective node. For large installations, the time saved in identifying the problem can be immense.

Line activity indicators can also point out other problems with the network. For example, line activity indicators light up when the MOD HUB is on and each ARCNET-compatible device that is connected to the MOD HUB is on. If a line activity indicator is not on for a device that is properly connected to the MOD HUB, then disconnect the cable from the connector and reconnect the cable to a similar vacant connector on another module. If the indicator on the other module does not light when the cable is connected, check the cable, the computer or the network interface module for possible problems.

If the line activity indicator goes on when the cable is plugged into another module, then the problem probably lies with the original module.

If a hub port has a line activity indicator that is on but no cable is attached to the connector, then the module is defective and should be returned. Contact our Customer Service Department.

## **2.10 Supporting Extended Timeouts**

Although seldom used, ARCNET networks can be configured for extended timeouts to facilitate geographically larger networks. In this situation, each network interface module must be configured for the same timeout. The MOD HUB will work with any of the four available timeout settings, but the RECON indicator will function unreliably if the reconfiguration detection circuitry is not configured for the same timeout as the network. There are four jumper settings on the timing module to accommodate extended timeouts. With the power removed from the MOD HUB, use a small star screwdriver to remove the timing module. Along one edge of the module is jumper setting E1. A jumper can be found installed in the NORM position. This is the factory setting and the default setting for standard ARCNET networks which is the shortest setting. The next



---

available setting is marked ET1, the next longest is ET2 and the longest is ET3. Simply move the jumper to the desired position.

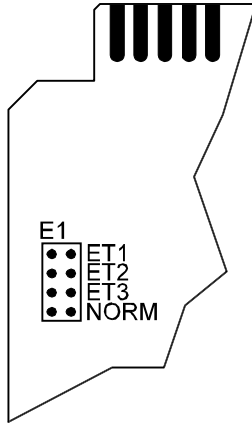

*Figure 2-5. The extended timeout settings only affect the RECON light with no affect to the hub operation.*

# 3 Operation

---

## 3.1 Theory of Operation

### Hub States

When the MOD HUB has installed expansion modules, the timing module waits for the first instance of an ARCNET signal on any one of its ports. During this time, the hub is in IDLE mode with all port receivers enabled and all port transmitters disabled. As soon as the first port senses an ARCNET signal (there should only be one in a normally operating ARCNET system), the hub enters the ACTIVE state with the receiving port left enabled and all other receivers disabled. During this state all transmitters are enabled with the receiving port's transmitter disabled. This allows all nodes on the network to hear a particular node which has momentary control of the network while squelching any echoes from unterminated lines (open or shorted cables). The hub remains in the ACTIVE mode until the last ARCNET signal is received by the originating port. To determine if the last signal has been sent, the hub times the absence of an ARCNET logic "1." Once the unlatch delay time is exceeded (typically 5.9 ms), the hub reverts back to the IDLE state.

### Signal Regeneration

To generate an ARCNET signal requires the synthesis of signals P1 and P2. These 100 ns non-overlapping pulses in turn drive the various transceivers on each of the expansion modules. A precision delay line gated oscillator forms the basis of the regeneration circuitry and was chosen because of the predictable delay experienced from this type of oscillator which is important in reducing bit jitter.

EIA-485 expansion modules incorporate a non-return to zero (NRZ) signalling scheme with a logic "1" signal equivalent to the logical OR of P1 and P2. The expansion modules

---

accommodate this signal generation while maintaining compatibility with coaxial and fiber optic signals.

### **Timers**

A simple crystal oscillator and divider are used to develop the unlatch delay time and reconfiguration timers. Although not critical, the unlatch delay timer is more repeatable from a crystal oscillator. However, the reconfiguration timer is more critical. The reconfiguration timer does not sense a reconfiguration on the network, it only predicts that a reconfiguration will occur. This is accomplished by noting that no data has occurred for 82  $\mu$ s (at standard timeouts). Once this timer is exceeded, the yellow RECON LED is lit for about 950 ms. If the hub is operated on a network with extended ARCNET timeouts, jumpers must be set on the timing module to extend the reconfiguration timer to match the network timeouts. There are a total of four jumper settings corresponding to the four possible timeouts.

### **Watchdog Timer**

If no hub activity is sensed after a predetermined time, a watchdog timer will automatically reset the MOD HUB timing module. This is to ensure that the hub reestablishes communication after a significant electrostatic or electromagnetic phenomenon without requiring any human intervention.

# 4 Service

---

More comprehensive information is on our web site at [www.ccontrols.com](http://www.ccontrols.com). This includes technical manuals and other documents. When contacting one of our offices, just ask for Technical Support.

## Warranty

Contemporary Controls (CC) warrants its new product to the original purchaser for two years from the product shipping date. Product returned to CC for repair is warranted for one year from the date that the repaired product is shipped back to the purchaser or for the remainder of the original warranty period, whichever is longer.

If a CC product fails to operate in compliance with its specification during the warranty period, CC will, at its option, repair or replace the product at no charge. The customer is, however, responsible for shipping the product; CC assumes no responsibility for the product until it is received.

CC's limited warranty covers products only as delivered and does not cover repair of products that have been damaged by abuse, accident, disaster, misuse, or incorrect installation. User modification may void the warranty if the product is damaged by the modification, in which case this warranty does not cover repair or replacement.

This warranty in no way warrants suitability of the product for any specific application. IN NO EVENT WILL CC BE LIABLE FOR ANY DAMAGES INCLUDING LOST PROFITS, LOST SAVINGS, OR OTHER INCIDENTAL OR CONSEQUENTIAL DAMAGES ARISING OUT OF THE USE OR INABILITY TO USE THE PRODUCT EVEN IF CC HAS BEEN ADVISED OF THE POSSIBILITY OF SUCH DAMAGES, OR FOR ANY CLAIM BY ANY PARTY OTHER THAN THE PURCHASER.

THE ABOVE WARRANTY IS IN LIEU OF ANY AND ALL OTHER WARRANTIES, EXPRESSED OR IMPLIED OR STATUTORY, INCLUDING THE WARRANTIES OF MERCHANTABILITY, FITNESS FOR PARTICULAR PURPOSE OR USE, TITLE AND NONINFRINGEMENT.

## Returning Products for Repair

Return the product to the loca<sup>n</sup> where it was purchased by following the instructions at the URL below:

[www.ccontrols.com/rma.htm](http://www.ccontrols.com/rma.htm)

## Declaration of Conformity

Additional compliance documentation can be found on our website.

# Appendix

---

## Permissible Segment Lengths

A segment is defined as any portion of the complete ARCNET cabling system isolated by one or more hub ports. On a hubless or bus system, the complete ARCNET cabling system consists of only one segment with several nodes; however, a system with hubs has potentially many segments. An ARCNET node is defined as a device with an active ARCNET controller chip requiring an ARCNET device address. Active and passive hubs do not utilize ARCNET addresses and, therefore, are not nodes. Each segment generally supports one or more nodes, but in the case of hub-to-hub connections there is the possibility that no node exists on that segment.

The permissible cable length of a segment depends upon the transceiver used and the type of cable installed. Table A-1 provides guidance on determining the constraints on cabling distances as well as the number of nodes allowed per bus segment.

The maximum segment distances are based upon nominal cable attenuation figures and worst case transceiver power budgets. Assumptions are noted.

When approaching the maximum limits, a link loss budget calculation is recommended.

When calculating the maximum number of nodes (except EIA-485 networks) on a bus segment, do not count the hub ports that terminate the bus segment as nodes.

However, do consider the maximum length of the bus segment to include the cable attached to the hub ports.

Several bus transceivers require a minimum distance between nodes. Adhere to this minimum since unreliable operation can occur.

## Appendix A (continued)

<b>Permissible Cable Lengths and Nodes Per Segment</b>			
<b>Trans-ceiver</b>	<b>Description</b>	<b>Cable</b>	<b>Connectors</b>
-CXS	coaxial star	RG-62/u	BNC
-CXS	coaxial star	RG-59/u	BNC
-CXB	coaxial bus	RG-62/u	BNC
-FOG	duplex fiber optic	50/125	SMA or ST
-FOG	duplex fiber optic	62.5/125	SMA or ST
-FOG	duplex fiber optic	100/140	SMA or ST
-FG3	duplex fiber optic	single mode	ST
-FG3	duplex fiber optic	50/125	ST
-FG3	duplex fiber optic	62.5/125	ST
-TPS	twisted-pair star	IBM Type 3	RJ-11
-TPB	twisted-pair bus	IBM Type 3	RJ-11
-485	DC-coupled EIA-485	IBM Type 3	RJ-11
-485X	AC-coupled EIA-485	IBM Type 3	RJ-11
<sup>1</sup>	This represents the minimum distance between any two nodes or between a node and a hub.		
<sup>2</sup>	May require a jumper change on the EXP to achieve this distance.		

*Table A-1. Permissible Cable Length and Nodes Per Segment*

<b>Cable Length</b>		<b>Max Nodes</b>	<b>Notes</b>
<b>Min</b>	<b>Max</b>	<b>Bus Segment</b>	
0	2000 ft/610 m	N/A	5.5 dB/1000 ft max
0	1500 ft/457 m	N/A	7.0 dB/1000 ft max
6 ft/2 m <sup>1</sup>	1000 ft/305 m	8	5.5 dB/1000 ft max
0	3000 ft/915 m	N/A	4.3 dB/km max
0	6000 ft/1825 m	N/A	4.3 dB/km max
0 <sup>2</sup>	9000 ft/2740 m	N/A	4.0 dB/km max
0 <sup>2</sup>	46000 ft/14000 m	N/A	0.5 dB/km max
0 <sup>2</sup>	32800 ft/10000 m	N/A	1.5 dB/km max
0 <sup>2</sup>	35000 ft/10670 m	N/A	1.5 dB/km max
0 <sup>2</sup>	330 ft/100 m	N/A	uses internal BALUNs
6 ft/2 m <sup>1</sup>	400 ft/122 m	8	
0	900 ft/274 m	17	DC coupled
0	700 ft/213 m	13	transformer isolated

---

[This page is deliberately left blank.]