

AI

*A Line of Fixed Port Active Hubs for ARCNET®
Local Area Networks*

User Manual

#TD675100-0MJ

CONTEMPORARY  **CONTROLS®**

Trademarks

Contemporary Controls, ARC Control, ARC DETECT and EXTEND-A-BUS are trademarks or registered trademarks of Contemporary Control Systems, Inc. ARCNET is a registered trademark of Datapoint Corporation. Other product names may be trademarks or registered trademarks of their respective companies.

TD675100-0MJ Revised April 2010.

Copyright

© Copyright January 1997-2010 by Contemporary Control Systems, Inc. All rights reserved. No part of this publication may be reproduced, transmitted, transcribed, stored in a retrieval system, or translated into any language or computer language, in any form or by any means, electronic, mechanical, magnetic, optical, chemical, manual, or otherwise, without the prior written permission of:

Contemporary Control Systems, Inc.
2431 Curtiss Street
Downers Grove, Illinois 60515 USA
Tel: 1-630-963-7070
Fax: 1-630-963-0109
E-mail: info@ccontrols.com
WWW: <http://www.ccontrols.com>

Contemporary Controls Ltd
Sovereign Court Two
University of Warwick Science Park
Sir William Lyons Road
Coventry CV4 7EZ UK
Tel: +44 (0)24 7641 3786
Fax: +44 (0)24 7641 3923
E-mail: ccl.info@ccontrols.com

Disclaimer

Contemporary Control Systems, Inc. reserves the right to make changes in the specifications of the product described within this manual at any time without notice and without obligation of Contemporary Control Systems, Inc. to notify any person of such revision or change.

Contents

Chapter 1	Introduction	1
1.1	Description	1
1.2	Features	2
1.3	Specifications	3
1.4	Ordering Information	5
Chapter 2	Installation	7
2.1	Introduction	7
2.2	Electromagnetic Compliance	7
2.3	Mounting the AI	8
2.4	Powering the AI	8
2.5	Topologies	11
2.6	Connecting Cables to the AI	12
2.7	Variable Data Rates	21
2.8	Supporting Extended Timeouts	22
Chapter 3	Operation	25
3.1	Theory of Operation	25
3.2	LED Indicators	26
3.3	Isolating Faulty Nodes with Line Activity Indicators	28
Chapter 4	Service	29
	Warranty	29
	Technical Support	30
	Warranty Repair	30
	Non-Warranty Repair	31
	Returning Products for Repair	31
Appendices		
	Appendix A—Permissible Segment Lengths	32
	Appendix B—Declaration of Conformity	35

List of Figures

Figure 2-1	DC Powered	9
Figure 2-2	Redundant DC Powered	9
Figure 2-3	AC Powered	10
Figure 2-4	AC Powered with Grounded Secondary	10
Figure 2-5	AC Powered with Battery Backup	11
Figure 2-6	Repeater	11
Figure 2-7	Link	12
Figure 2-8	Hub	12
Figure 2-9	DC Coupled EIA-485 Option (-485)	16
Figure 2-10	Each -485 Hub Port Has Provisions For Applying Bias and Termination	17
Figure 2-11	AC Coupled EIA-485 Option (-485X)	19
Figure 2-12	RJ-11 Connections Found on CC's NIMs	19
Figure 2-13	AI Twisted-Pair Pinouts	20
Figure 2-14	Front Panel of the AI2 and AI3	20
Figure 2-15	RJ-45 Connector Pin Assignments	21
Figure 2-16	Data Rate Switch	22
Figure 2-17	Extended Timeout Jumpers	23

1 Introduction

1.1 Description

The ARCNET Interconnect (AI) series of external fixed port hubs provide a low cost method of expanding ARCNET local area networks. Expansion methods include the use of repeaters, links and hubs. Repeaters are used to extend a wiring segment using the same cabling technology. A link allows the mixing of two cabling technologies within one segment. A hub allows for the addition of a segment and support for distributed star topologies. The AI can implement all three expansion methods depending upon the number of ports on the AI. The AI2 provides two ports for repeater and link applications while the AI3 implements the hub function. However, the AI2 and AI3 utilize the same robust hub timing electronics found in Contemporary Controls' (CC's) MOD HUB series of modular active hubs. This includes precision delay line timing, digitally controlled timers for dependable operation and reduced bit jitter.

The AI operates from either low voltage AC or DC power. For DC operation, a voltage source in the range of 10 to 36 volts is required. For AC operation, a voltage source in the range of 8 to 24 volts is required. Companion regulatory approved transformers are available under separate model numbers for UL and CE Mark applications.

The timing electronics uses a precision delay line timing generator which regenerates the incoming ARCNET signal without introducing excessive bit jitter. The regenerated signal is then sent to all other ports on the hub. A watchdog timer is included to prevent the possibility of hub lockup eliminating the necessity of cycling power on a failed hub. The hub unlatch delay time is derived from a crystal oscillator for high accuracy and repeatability. The AI series supports variable data rates from 78 kbps to 10 Mbps in order to accommodate newer ARCNET controller chips and popular EIA-485 transceivers.

Active hubs increase the robustness of ARCNET networks. They maximize the distance that can be achieved on each cable segment—up to 2000 feet on coaxial segments. They prevent interference to the network by squelching reflections caused by open or shorted cable segments attached to the hub. Unused hub ports need not be terminated. Active hubs allow for a distributed star topology, thereby minimizing the cabling required in a plant. Active links and repeaters provide extensions to bus systems or bridging to other cable media.

1.2 Features

- Compatible with the baseband ARCNET network
- Compatible with all CC's network interface modules (NIMs) and active hubs
- Supports either 2 or 3 ports
- Panel-mount enclosure
- Configurations available for either link, repeater or hub operation
- Supports coaxial, twisted-pair and fiber optic cable
- LED indicator identifies reconfiguration of the network
- Minimizes bit jitter with precision delay line timing
- Watchdog timer prevents hub lockup
- Hub unlatch delay digitally controlled
- Low voltage AC or DC powered
- Provisions for redundant power supplies
- Supports variable data rates from 78 kbps to 10 Mbps
- Accommodates AC or DC coupled EIA-485 networks

1.3 Specifications

Electrical

	DC	AC
Input voltage:	10–36 V	8–24 V
Input power:	4 W	4 VA
Input frequency:	N/A	47–63 Hz

Mechanical

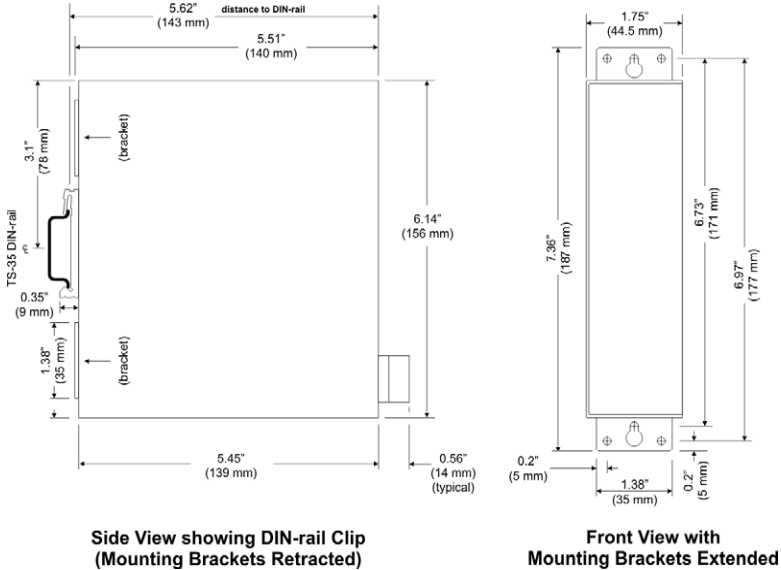

Optical Power Budget (25°C)

Fiber Size (Microns)	-FOG 850 nm (dB)
50/125	6.6
62.5/125	10.4
100/140	15.9

Environmental

Operating temperature: 0°C to +60°C
 Storage temperature: -40°C to +85°C

Functional

Transceiver	Data Rate (bps)							
	78K	156K	312K	625K	1.25M	2.5M	5M	10M
-CXS						■		
-CXB						■		
-TPB						■		
-FOG	■							
-485	■							
-485X						■		

The data rate switch is not present on the -CXS, -CXB and -TPB models.

Compliance: ANSI/ATA 878.1

Extended timeouts: Supports all three extended ARCNET timeouts

Hub, Repeaters and

Link delay: 320 ns maximum @ 2.5 Mbps

Unlatch delay time: 5.9 μ s @ 2.5 Mbps

LED indicators: RECON–yellow
ACTIVITY–green
STATUS–green

Regulatory Compliance

CE Mark

CFR 47, Part 15 Class A

1.4 Ordering Information

The AI series is available in several configurations depending upon the application and cable media supported.

Repeaters

AI2-CXB	Coaxial bus repeater
AI2-TPB	Twisted-pair bus repeater
AI2-485	DC coupled EI-485 repeater
AI2-485X	AC coupled EIA-485 repeater

Links

AI2-CXB/FOG-ST	Coaxial bus to fiber optic link
AI2-TPB/FOG-ST	Twisted-pair bus to fiber optic link
AI2-485/FOG-ST	DC EIA-485 to fiber optic link
AI2-485X/FOG-ST	AC EIA-485 to fiber optic link

Hubs

AI3-CXS	Coaxial star hub
AI3-TB5	Twisted-pair bus hub
AI3-485	DC coupled EIA-485 hub
AI3-485X	AC coupled EIA-485 hub
AI3-485/FOG-ST	DC coupled EIA-485 to fiber hub
AI3-485X/FOG-ST	AC coupled EIA-485 to fiber hub
AI3-FOG-ST/TB5	Twisted-pair bus/fiber backbone hub
AI3-FOG-ST/CXB	Coaxial bus/fiber backbone hub
AI3-FOG-ST/485	DC Coupled EIA-485/fiber backbone hub
AI3-FOG-ST/485X	AC Coupled EIA-485/fiber backbone hub

Accessories

AI-XFMR	Wall-mount transformer 120 Vac (nom)
AI-XFMR-E	Wall-mount transformer 230 Vac (nom)
AI-DIN	DIN-rail mounting kit
BNC-T	BNC "T" connector
BNC-TER	93 ohm BNC terminator

Contact factory regarding special requirements.

2 Installation

2.1 Introduction

The AI series is intended to be panel mounted into an industrial enclosure or into a wiring closet. This can be achieved with either panel-mounting brackets or clipping onto DIN rail as described in Section 2.3.

2.2 Electromagnetic Compliance

The AI series complies with Class A radiated and conducted emissions as defined by CFR 47, Part 15 and EN55022. This equipment is intended for use in nonresidential areas. Refer to the following notices in regard to the location of the installed equipment.

Note: This equipment has been tested and found to comply with the limits for a Class A digital device, pursuant to the rules of CFR 47, Part 15. These limits are designed to provide reasonable protection against harmful interference when the equipment is operated in a commercial environment. This equipment generates, uses, and can radiate radio frequency energy and, if not installed and used in accordance with the instruction manual, may cause harmful interference to radio communications. Operation of this equipment in a residential area is likely to cause harmful interference in which case the user will be required to correct the interference at his own expense.

Warning

This is a Class A product as defined in EN55022. In a domestic environment this product may cause radio interference in which case the user may be required to take adequate measures.

The AI has been tested to EN55024 Generic Immunity Standard—Industrial Environment. This standard identifies a series of tests requiring the equipment to perform to a particular level during or after the execution of the tests. The three classes of performance are defined by CC as follows:

Class A — Normal operation, however, occasional reconfigurations may occur or throughput reduced due to error recovery algorithm by the ARCNET data link level protocol.

Class B — Throughput reduced to zero and continuous reconfigurations occur. Normal operation resumed after offending signal removed.

Class C — Complete loss of function. Unit resets and normal operation restored without human intervention.

At no time did the AI fail to return to normal operation or become unsafe during the execution of these tests.

A copy of the Declaration of Conformity is in the appendix.

2.3 Mounting the AI

The AI Series can be snap-mounted onto TS-35 DIN-rail using the pre-attached DIN-rail clip. If the clip is removed, the unit can be panel mounted using the adjustable brackets affixed to rear of the enclosure. (See the dimensional drawing in Section 1.3 for details).

2.4 Powering the AI

The AI requires either low voltage AC or DC power in order to operate. Consult the specifications for power requirements. Power is provided to a four pin removable keyed connector and there are several methods for providing power.

2.4.1 DC Powered

Make connections as shown in the diagram. The AI Series incorporates a DC-DC converter that accepts a wide voltage range (10–36 Vdc) and converts the voltage for internal use. Input current varies with input voltage so it is important to size the power conductors accordingly. Input power to the AI does not exceed 4 watts; therefore, at 10 Vdc, the input current is approximately 400 mA. The ground connection to the AI is connected to chassis within the AI. The input connections are reverse-voltage protected.

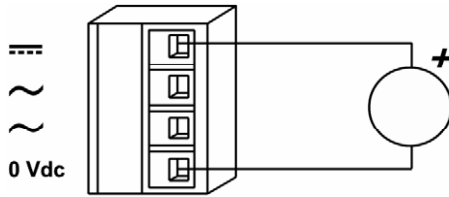

Figure 2-1. DC Powered

2.4.2 Redundant DC Powered

Redundant diode isolated DC power inputs are provided on the AI for those applications where there is a concern that the AI remain operational in the event of a primary power failure. Make connections as shown in the diagram. Each power supply source must be sized for the full 4 watt load of the AI. Do not assume that input currents will be balanced from the two supplies.

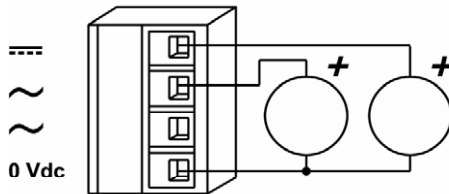

Figure 2-2. Redundant DC Powered

2.4.3 AC Powered

If only AC power is available, the AI can be powered by the secondary of a low voltage transformer whose primary is connected to the AC mains. The secondary voltage must be in the range of 8 to 24 Vac with the capability of delivering up to 4 VA of apparent power. The secondary of the transformer must not be grounded. When using a grounded secondary transformer refer to Figure 2-4. For convenience two auxiliary power supplies are available. The AI-XFMR is intended for 120 Vac primary power while the AI-XFMR-E is intended for 230 Vac.

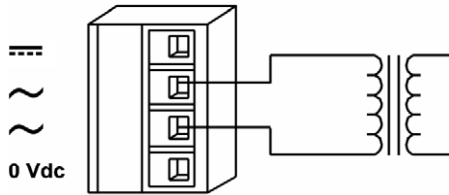

Figure 2-3. AC Powered

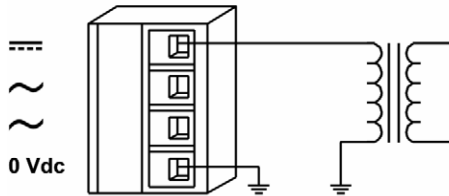

Figure 2-4. AC Powered with Grounded Secondary

2.4.4 AC Powered with Battery Backup

The AI can also be powered from both an AC and DC power source. Usually the DC source is from a battery supply which is connected as the DC powered option. Refer to the diagram for details. In this application, the AI does not charge the battery so separate provisions are required for charging. If the AC source fails, the AI will operate from the battery source.

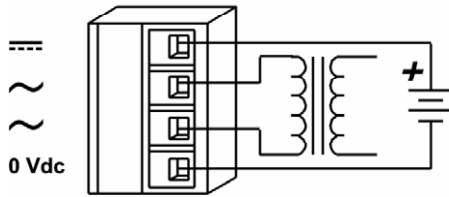

Figure 2-5. AC Powered with Battery Backup

2.5 Topologies

Depending upon the number of ports on the AI, the AI can be used as either a repeater, link or hub. The AI2 has only two ports and, therefore, can be used as a repeater or link while the AI3 has three ports and can be used as a hub.

2.5.1 Repeater

The repeater extends wiring segments of the same type of cable. Coaxial cable or twisted-pair segments can be extended using repeaters.

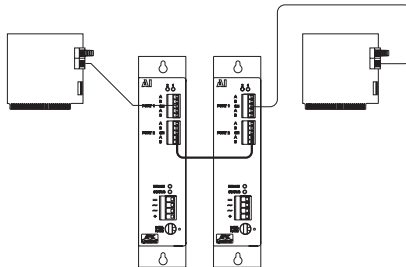

Figure 2-6. Repeater

2.5.2 Link

A link converts one type of cabling segment into another. Using two AIs in a link application, either a coaxial or twisted-pair segment can be converted into a fiber segment.

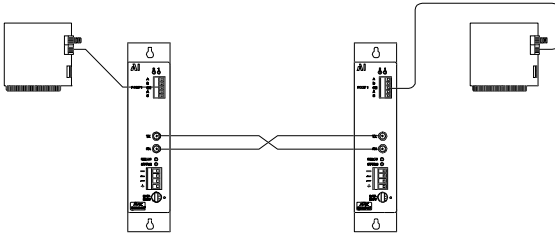

Figure 2-7. Link

2.5.3 Hub

With a three port AI, the hub (or star topology) configuration can be implemented. AI3s can also be cascaded in order to create a distributed star topology.

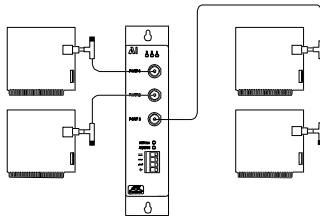

Figure 2-8. Hub

2.6 Connecting Cables to the AI

The AI provides either two or three ports preconfigured for either coaxial, twisted-pair or fiber optic cable. More information on designing an ARCNET cabling system can be found in CC's publication "*ARCNET Tutorial Product Guide.*"

Attach the coaxial, twisted-pair or fiber optic cables to the devices that are being networked in the ARCNET LAN (refer to Appendix A to verify that maximum cabling distance specifications are not exceeded).

2.6.1 *Connecting Coaxial Cable Star Networks (-CXS)*

There are generally two types of coaxial cables that are used with ARCNET, RG-59/u and RG-62/u. RG-59/u is 75 ohm cable which does not precisely match the impedance of the transceivers used on the AI ports. This cable will work, but communication distances are reduced compared to RG-62/u because of the higher attenuation of RG-59/u cable. We recommend RG-62/u because it is a better match to the transceivers and a full 2000 foot segment distance can be achieved using this cable. Both cables support male BNC connectors which the -CXS port accommodates. When connecting to a -CXS port, do not apply a terminator or BNC “T” connector to the port. Simply connect the coaxial cable to the BNC port.

2.6.2 *Connecting Coaxial Cable Bus Networks (-CXB)*

Some AI2 link and repeater models support coaxial bus transceivers (-CXB) which allows the insertion of an AI at any point within a bus segment. Usually, RG-62/u coaxial cable is used to connect the various nodes and the AI requiring 93 ohms of passive termination at the extreme ends of the bus segment. This is accomplished using a BNC terminator (BNC-TER) and BNC “T” connector (BNC-T) at each end. A BNC “T” connector is then used to interconnect the various devices within the segment. Make sure that all devices are -CXB compliant.

If a bus segment is to be connected to a coaxial star port (-CXS), connect the -CXS port only at the extreme ends of the bus segment without a passive terminator. The -CXS port effectively terminates the bus segment without the need for additional termination.

2.6.3 Connecting Twisted-Pair Bus Networks (-TPB)

Some AI2 link and repeater models have twisted-pair transceivers (-TPB) which allows the insertion of an AI at any point within a bus segment. Usually IBM type 3 unshielded twisted-pair cable is (UTP) used, although shielded cable can be used as well. A removable 5-position screw connector is used to make connections. The middle pin is reserved for the shield connection while phases A and B are available on each of two pins to facilitate daisy-chain connections (within a bus segment) or to attach a passive termination (at the end devices). End devices require a passive terminator that matches the impedance of the cable (typically 100 ohms).

2.6.4 Connecting Fiber Optic Cable (-FOG)

Multimode fiber optic cable is typically available in three sizes, 50/125, 62.5/125, and 100/140. The larger the size, the more energy that can be launched and, therefore, the greater the distance. Bayonet style ST connectors, similar in operation to BNC coaxial cable connectors, are provided for making the fiber connections.

Fiber optic connections require a duplex cable arrangement. Two unidirectional cable paths provide the duplex link. There are two devices on the AI fiber port. One device, colored light gray, is the transmitter and the other, dark gray, is the receiver. Remember that “light goes out of the light (gray).” To establish a working link between a hub and a network interface module or a hub to another hub, the transmitter of point A must be connected to a receiver at point B. Correspondingly the receiver at point A must be connected to a transmitter at point B. This establishes the duplex link which is actually two simplex links. Fiber optic cable is available paired for this purpose. Usually the manufacturers’ labeling is only on one cable of the pair which is handy for identifying which of the two cables is which. Establish your own protocol for connecting cable between hubs and NIMs in the field using the manufacturers’ labeling as a guide. However, remember that to connect point A

to point B requires a paired fiber optic cable and that the light gray connector at one point must connect to a dark gray connector at the other point.

2.6.5 Connecting DC Coupled EIA-485 Networks (-485)

A removable 5-position screw connector is provided for each DC coupled EIA-485 segment. Two connections are provided for each differential signal phases A and B. The middle pin connects to a 100 ohm resistor referenced to DC common. This segment can be up to 900 feet long of IBM type 3 unshielded twisted-pair cable, and as many as 17 nodes can occupy the segment. Make sure that the phase integrity of the wiring remains intact. All phase A signals on the AI network interface modules and other hubs must be connected together. The same applies to phase B. Figure 2-6 has been provided to assist in connecting the various devices. If shielded cable is to be used, the shielded end can be terminated to the middle pin on the connector.

Termination

Each end of the segment must be terminated in the characteristic impedance of the cable. A 120 ohm resistor can be invoked with a jumper which resides on the EIA-485 daughterboard adjacent to the port connector. With the middle jumper inserted at location E1 on the daughterboard, 120 ohms of resistance is applied across the twisted-pair. With the jumper removed, no termination is applied. If it is desired to apply external termination instead, remove this jumper and connect an external resistor across phase A and phase B.

Failsafe Bias

In addition to the termination, it is also necessary to apply bias to the twisted-pair network so that when the line is floated differential receivers will not assume an invalid logic state. There are two precision bias resistors (Rb) of equal value on each daughterboard. One resistor is tied to the +5V line while

the other is tied to ground. Each resistor has a jumper associated with it. If the two jumpers are installed, the resistor tied to +5V is connected to the phase A signal line while the grounded resistor is connected to the phase B line. This voltage drop will bias the differential receivers into a defined state when no differential drivers are enabled. Differential receivers typically switch at or near zero volts differential and are guaranteed to switch at ± 200 mV. Through the transition point, 70 mV of hysteresis will be experienced. Therefore, a positive bias of 200 mV or greater will ensure a defined state. We recommend that bias be applied to both ends of the wiring segment by installing the two end jumpers located at position E1 on the daughterboard. This is to be done for only the AI ports or NIMs located at the ends of the segment. All other NIMs will have their jumpers removed.

The termination and bias rules are simple. If the NIM or AI port is located at the extreme ends of the segment, install all three jumpers at location E1 on the daughterboard. If the NIM is located between the two end NIMs or AI ports, remove all three jumpers. If external termination is desired, remove the middle jumper at E1 and provide the external termination.

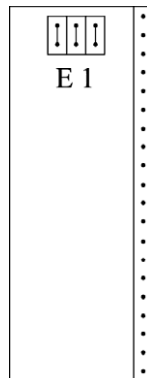

Figure 2-9. DC Coupled EIA-485 Option (-485)

For EIA-485 DC operation, it is very important that all devices on the wiring segment be referenced to the same ground potential in order that the common mode voltage requirement (± 7 Vdc) of the EIA-485 specification is achieved. This can be accomplished by running a separate ground wire between all AIs and computers (pin SH has been provided for such a connection on the AI) or by relying upon the third wire ground of the power connector assuming that the DC power return is connected to chassis ground on all computers (this is the case with the AI). Another approach would be to connect the DC common of each computer to a cold water pipe. Connected systems, each with different elevated grounds, can cause unreliable communications or damage to the EIA-485 differential drivers. Therefore, it is important that an adequate grounding method be implemented.

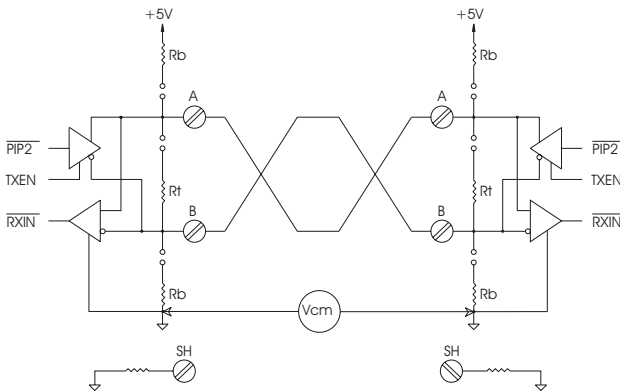

Figure 2-10. Each -485 hub port has provisions for applying bias and termination. Make sure common mode voltage (Vcm) does not exceed ± 7 Vdc.

In summary, segments of -485 (-485D) connected NIMs can be extended through the use of active hubs. Select an AI model with a -485 compatible port. Connect one end of the segment to this port following the same termination rules as used for a

NIM. This hub port counts as one NIM when cable loading is being calculated. The NIM electrically closest to the hub port should not have any termination or bias applied. Follow the same rules for other segments attached to different hub ports. Each hub effectively extends the segment another 900 feet. Maintain the same cabling polarity as the NIMs by using cable connections that do not invert the signals.

2.6.6 Connecting AC Coupled EIA-485 Networks (-485X)

The AC coupled EIA-485 transceiver offers advantages over the DC coupled EIA-485. No bias adjustments need to be made since each transceiver has its own fixed bias network isolated by a pulse transformer. Unlike the DC coupled EIA-485, wiring polarity is unimportant. Either inverted or straight through cable can be used or even mixed within one AC coupled network. Much higher common mode voltage levels can be achieved with AC coupling due to the transformer coupling which has a 1000 Vdc breakdown rating.

There are disadvantages to the AC coupled transceiver as compared to the DC coupled technology. The DC coupled distances are longer (900 feet) compared to the AC coupled distance (700 feet) and the node count is higher with DC. The AC coupled transceiver will only operate between 1.25 Mbps and 10 Mbps.

The cabling rules of the -485X are similar to the -485. Wire a maximum of 13 NIMs (reduce by one for each AI port) in a daisy-chain fashion leaving the end devices as either NIMs or AI ports. On these NIMs or AI ports insert a jumper at E1 on both -485X daughterboards to invoke 120 ohm termination resistors or leave the jumpers open and connect an external terminating resistor to phases A and B. Termination should not be applied to any of the NIMs located between the two end NIMs or AI ports of the segment. Mixing -485 and -485D can be accomplished by invoking backplane mode on -485 NIMs and non-backplane mode on -485D NIMs.

However, -485 or -485D NIMs cannot be mixed with -485X NIMs together on one segment since signal encoding is different.

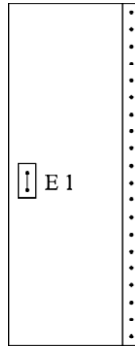

Figure 2-11. AC Coupled EIA-485 Option (-485X)

WIRING CHART RJ-11 CONNECTOR				
PIN	-TPS	-TPB	-485	-485X
1	—	—	—	—
2	N/C	N/C	N/C	N/C
3	LINE+	LINE-	LINE-	LINE
4	LINE-	LINE+	LINE+	LINE
5	N/C	N/C	N/C	N/C
6	—	—	—	—

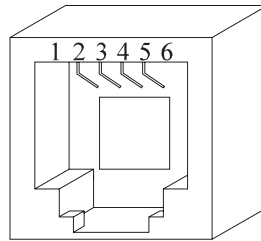

Figure 2-12. RJ-11 Connections Found on CC's NIMs

PIN	-TPB	-485	-485X
A	LINE+	LINE+	LINE
B	LINE-	LINE-	LINE
SH	SHIELD	SHIELD	SHIELD
A	LINE+	LINE+	LINE
B	LINE-	LINE-	LINE

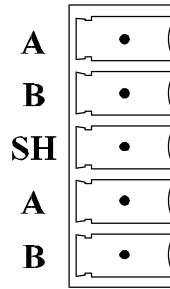

Figure 2-13. AI Twisted-Pair Pinouts

NOTE: For -TPB transceiver, LINE+ is defined at the leading positive phase of the dipulse signal. For -485 transceiver, LINE+ is defined as the pin with the more positive applied failsafe bias. The -485X transceiver is not polarized.

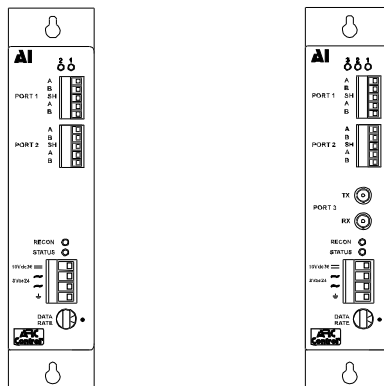

Figure 2-14. Front Panel of the AI2 (left) and AI3 (right)

2.6.7 Connecting Shielded Twisted-Pair Bus Networks via RJ-45 Connectors (-TB5)

Some AI3 models support twisted-pair bus operation via dual connectors. This allows insertion of the AI at any location on the bus segment and provides continuous shielding between devices. When the TB5 port is located at the end of a bus segment, passive termination is required at the unused jack to match the cable impedance (typically 100 ohms). Refer to Figure 2-15 for the RJ-45 connector pin assignments.

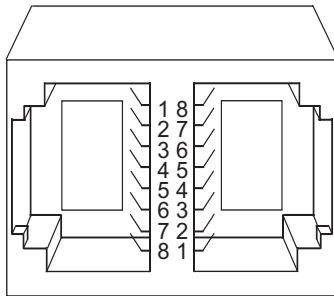

Figure 2-15. RJ-45 Connector Pin Assignments

2.7 Variable Data Rates

Newer ARCNET controller chips support variable data rates up to 10 Mbps. However, transceivers such as -CXS, -CXB and -TPB will only operate at 2.5 Mbps. On these AI models there are no provisions for variable data rates as evidenced by the lack of a data rate switch. On all other models, a data rate switch is present which must be set to the correct speed of the network. A table has been provided to aid in setting the 8 position switch. Switch positions are labeled 0-7 with position 6 further identified by a dot indicating the 2.5 Mbps default position. A clockwise rotation increases the data rate setting. Use the following table to set the data rate:

POS	RATE (bps)
1	78K
2	156K
3	312K
4	625K
5	1.25M
• 6	2.5M
7	5M
0	10M



Data rate switch set to the default position 6 (2.5 Mbps).

Figure 2-16. Data Rate Switch

NOTE: On -485X models data rates less than 1.25 Mbps are not supported.

2.8 Supporting Extended Timeouts

Although seldom used, ARCNET networks can be configured for extended timeouts to facilitate geographically larger networks. In this situation, each network interface module must be configured for the same timeout. The AI will work with either of the four available timeout settings, but the RECON indicator will function unreliably if the reconfiguration detection circuitry is not configured for the same timeout as the network. There are four jumper settings on the AI to accommodate extended timeouts. On the board is jumper setting E1. The jumper can be found installed in the NORM position. This is the factory setting and the default setting for standard ARCNET networks which is the shortest setting. The next available setting is marked ET1, the next longest is ET2 and the longest is ET3. Simply move the jumper to the desired position. With newer ARCNET controller chips, the reconfiguration timers are programmable and there may be no appropriate timeout setting. To disable the RECON light, remove any jumpers from NORM, ET1, ET2 or ET3.

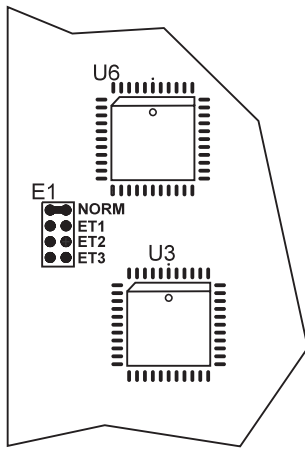

Figure 2-17. Extended Timeout Jumpers



3 Operation

3.1 Theory of Operation

3.1.1 AI States

When the AI has installed expansion modules, the timing module waits for the first instance of an ARCNET signal on any one of its ports. During this time, the hub is in IDLE mode with all port receivers enabled and all port transmitters disabled. As soon as the first port senses an ARCNET signal (there should only be one in a normally operating ARCNET system), the hub enters the ACTIVE state with the receiving port left enabled and all other receivers disabled. During this state all transmitters are enabled with the receiving port's transmitter disabled. This allows all nodes on the network to hear a particular node which has momentary control of the network while squelching any echoes from unterminated lines (open or shorted cables). The AI remains in the ACTIVE mode until the last ARCNET signal is received by the originating port. To determine if the last signal has been sent, the AI times the absence of an ARCNET logic "1." Once the unlatch delay time is exceeded (typically 5.9 μ s when operating at 2.5 Mbps), the AI reverts back to the IDLE state.

3.1.2 Signal Regeneration

To generate an ARCNET signal requires the synthesis of signals P1 and P2. These 100 ns non-overlapping pulses (when operating at 2.5 Mbps) in turn drive the various transceivers on each of the ports. A precision delay line gated oscillator forms the basis of the regeneration circuitry and was chosen because of the predictable delay experienced from this type of oscillator which is important in reducing bit jitter.

EIA-485 ports incorporate a return to zero (RZ) signaling scheme with a logic "1" signal equivalent to the logical OR of

P1 and P2. These ports accommodate this signal generation while maintaining compatibility with coaxial and fiber optic signals.

3.1.3 Timers

A simple crystal oscillator and divider are used to develop the unlatch delay time and reconfiguration timers. Although not critical, the unlatch delay timer is more repeatable from a crystal oscillator. However, the reconfiguration timer is more critical. The reconfiguration timer does not sense a reconfiguration on the network, it only predicts that a reconfiguration will occur. This is accomplished by noting that no data has occurred for 82 μ s (at standard timeouts and at 2.5 Mbps). Once this timer is exceeded, the yellow RECON LED is lit for about 950 ms. If the hub is operated on a network with extended ARCNET timeouts, jumpers must be set on the timing module to extend the reconfiguration timer to match the network timeouts. There are a total of four jumper settings corresponding to the four possible timeouts. Newer ARCNET controller chips allow for adjustable reconfiguration timers beyond the original standards. These settings could confuse the RECON LED. To disable the RECON LED, simply remove any jumper attached to the four timeout positions.

3.1.4 Watchdog Timer

If no hub activity is sensed after a predetermined time, a watchdog timer will automatically reset the AI timing electronics. This is to ensure that the AI reestablishes communication after a significant electrostatic or electromagnetic phenomenon without requiring any human intervention.

3.2 LED Indicators

There are several LED indicators on the AI that aid in determining if the network is operating correctly. The indicators are as follows:

ACTIVITY Each port on the AI has an associated LED indicator that indicates that ARCNET traffic is being received on that port. The intensity of the LED will increase somewhat with traffic. Transmitted data from that port is not indicated by the **ACTIVITY** light. Therefore, disconnected cables, open cables or cables attached to disabled ARCNET controller chips will not light the **ACTIVITY** LED.

STATUS With power applied and with no network cables connected to the AI or if no valid ARCNET activity is present on any one port on the AI, this indicator will flash at a periodic rate indicating that the AI is functioning but idle. If ARCNET activity is present and the internal regeneration of the ARCNET signal is proper, this indicator will light, telling you that the AI is receiving ARCNET signals and (faithfully) reproducing these signals to other ports on the AI. If this indicator does not light when activity is present on any hub port, as it should, then the AI is defective.

RECON Reconfigurations of the network routinely occur as nodes are added to the network and pose no problem to the network. When they occur, this LED will flash on for one second to facilitate viewing even though the reconfiguration process takes a fraction of a second. However, frequent reconfigurations can degrade performance of the network as indicated by this LED flashing repeatedly or lighting continuously. If this is occurring on your AI, you need to isolate the connected computers to find out which node is causing these reconfigurations.

The cause of frequent reconfigurations could be a faulty network interface module, defective cable, duplicate node IDs, or a high incidence of electrical interference. An occasional flash of this light is normal as automatic reconfigurations are a feature of ARCNET. If this is all that is viewed, you can feel well assured that the network is operating properly.

3.3 Isolating Faulty Nodes with Line Activity Indicators

The AI has port activity indicators. Each port activity indicator lights whenever the corresponding port on the AI receives ARCNET signals. The intensity of these indicator lights changes with the amount of activity and this is how defective nodes can be isolated.

The worst possible occurrence is the “chattering node.” A chattering node generates reconfigurations continuously, as evidenced by the RECON light being continuously lit, because this node has a defective receiver on its network interface module. Under these circumstances, the port activity indicator that corresponds to the port on the AI connected to the chattering node will light brightly while all other port activity indicators will appear dim. Disconnecting this cable from the AI will extinguish the RECON indicator and return all other port activity lights to equal brightness, thereby isolating the defective node. For large installations, the time saved in identifying the problem can be immense.

Port activity indicators can also point out other problems with the network. For example, port activity indicators light up when the AI is on and each ARCNET compatible device that is connected to the AI is on. If a port activity indicator is not on for a device that is properly connected to the AI, then disconnect the cable from the port and reconnect the cable to a similar vacant port. If the indicator on the other port does not light when the cable is connected, check the cable, the computer or the network interface module for possible problems.

If the port activity indicator goes on when the cable is plugged into another port, then the problem probably lies with the original port on the AI.

If an AI port has a line activity indicator that is on but no cable is attached to the connector, then the port is defective and the AI should be returned. Contact our Customer Service department.

4 Service

Warranty

Contemporary Controls (CC) warrants its new product to the original purchaser for two years from the product shipping date. Product returned to CC for repair is warranted for one year from the date that the repaired product is shipped back to the purchaser or for the remainder of the original warranty period, whichever is longer.

If a CC product fails to operate in compliance with its specification during the warranty period, CC will, at its option, repair or replace the product at no charge. The customer is, however, responsible for shipping the product; CC assumes no responsibility for the product until it is received.

CC's limited warranty covers products only as delivered and does not cover repair of products that have been damaged by abuse, accident, disaster, misuse, or incorrect installation. User modification may void the warranty if the product is damaged by the modification, in which case this warranty does not cover repair or replacement.

This warranty in no way warrants suitability of the product for any specific application. IN NO EVENT WILL CC BE LIABLE FOR ANY DAMAGES INCLUDING LOST PROFITS, LOST SAVINGS, OR OTHER INCIDENTAL OR CONSEQUENTIAL DAMAGES ARISING OUT OF THE USE OR INABILITY TO USE THE PRODUCT EVEN IF CC HAS BEEN ADVISED OF THE POSSIBILITY OF SUCH DAMAGES, OR FOR ANY CLAIM BY ANY PARTY OTHER THAN THE PURCHASER.

THE ABOVE WARRANTY IS IN LIEU OF ANY AND ALL OTHER WARRANTIES, EXPRESSED OR IMPLIED OR STATUTORY, INCLUDING THE WARRANTIES OF MERCHANTABILITY, FITNESS FOR PARTICULAR PURPOSE OR USE, TITLE AND NONINFRINGEMENT.

Repair or replacement as provided above shall be the purchaser's sole and exclusive remedy and CC's exclusive liability for any breach of warranty.

Technical Support

Contemporary Controls (U.S.A.) will provide technical support on its products by calling 1-630-963-7070 each weekday (except holidays) between 8:00 a.m. and 5:00 p.m. Central time.

Contemporary Controls Ltd (U.K.) will provide technical support on its products by calling +44 (0)24 7641 3786 each weekday (except holidays) between 8:00 a.m. and 5:00 p.m. United Kingdom time. If you have a problem outside these hours, leave a voice-mail message in the CC after hours mailbox after calling our main phone number. You can also fax your request by calling 1-630-963-0109 (U.S.) or +44 (0)24 7641 3923 (U.K.), or contact us via e-mail at info@ccontrols.com or ccl.info@ccontrols.com. You can visit our web site at www.ccontrols.com. When contacting us, please leave a detailed description of the problem. We will contact you by phone the next business day or in the manner your instructions indicate. We will attempt to resolve the problem over the phone. If unresolvable, the customer will be given an RMA number in order that the product may be returned to CC for repair.

Warranty Repair

Products under warranty that were not subjected to misuse or abuse will be repaired at no charge to the customer. The customer, however, pays for shipping the product back to CC while CC pays for the return shipment to the customer. CC normally ships ground. International shipments may take longer. If the product has been determined to be misused or abused, CC will provide the customer with a quotation for repair. No work will be done without customer approval.

Non-Warranty Repair

CC provides a repair service for all its products. Repair charges are based upon a fixed fee basis depending upon the complexity of the product. Therefore, Customer Service can provide a quotation on the repair cost at the time a Returned Material Authorization (RMA) is requested. Customers pay the cost of shipping the defective product to CC and will be invoiced for the return shipment to their facility. No repair will be performed without customer approval. If a product is determined to be unrepairable, the customer will be asked if the product can be replaced with a refurbished product (assuming one is available). Under no circumstances will CC replace a defective product without customer approval. Allow ten working days for repairs.

Returning Products for Repair

Return the product to the location where it was purchased by following the instructions at the URL below:

www.ccontrols.com/rma.htm

Appendices

Appendix A — Permissible Segment Lengths

A segment is defined as any portion of the complete ARCNET cabling system isolated by one or more hub ports. On a hubless or bus system, the complete ARCNET cabling system consists of only one segment with several nodes; however, a system with hubs has potentially many segments. An ARCNET node is defined as a device with an active ARCNET controller chip requiring an ARCNET device address. Active and passive hubs do not utilize ARCNET addresses and, therefore, are not nodes. Each segment generally supports one or more nodes, but in the case of hub-to-hub connections there is the possibility that no node exists on that segment.

The permissible cable length of a segment depends upon the transceiver used and the type of cable installed. Table A-1 provides guidance on determining the constraints on cabling distances as well as the number of nodes allowed per bus segment.

The maximum segment distances are based upon nominal cable attenuation figures and worst case transceiver power budgets. Assumptions are noted.

When approaching the maximum limits, a link loss budget calculation is recommended.

When calculating the maximum number of nodes (except EIA-485 networks) on a bus segment, do not count the hub ports that terminate the bus segment as nodes.

However, do consider the maximum length of the bus segment to include the cable attached to the hub ports.

Several bus transceivers require a minimum distance between nodes. Adhere to this minimum since unreliable operation can occur.

Appendix A (continued)

Permissible Cable Lengths and Nodes Per Segment			
Trans- ceiver	Description	Cable	Connectors
-CXS	coaxial star	RG-62/u	BNC
-CXS	coaxial star	RG-59/u	BNC
-CXB	coaxial bus	RG-62/u	BNC
-FOG	duplex fiber optic	50/125	SMA or ST
-FOG	duplex fiber optic	62.5/125	SMA or ST
-FOG	duplex fiber optic	100/140	SMA or ST
-TPB	twisted-pair bus	IBM type 3	RJ-11
-485	DC coupled EIA-485	IBM type 3	RJ-11
-485X	AC coupled EIA-485	IBM type 3	RJ-11

¹ This represents the minimum distance between any two nodes or between a node and a hub.

² May require a jumper change on the AI to achieve this distance.

*Table A-1. Permissible Cable Length
and Nodes Per Segment*

(2.5 Mbps)

Cable Length		Max Nodes	Notes
Min	Max	Bus Segment	
0	2000ft/610m	N/A	5.5 dB/1000ft max
0	1500ft/457m	N/A	7.0 dB/1000ft max
6ft/2m ¹	1000ft/305m	8	5.5 dB/1000ft max
0	3000ft/915m	N/A	4.3 dB/km max
0	6000ft/1825m	N/A	4.3 dB/km max
0 ²	9000ft/2740m	N/A	4.0 dB/km max
6ft/2m ¹	400ft/122m	8	
0	900ft/274m	17	DC coupled
0	700ft/213m	13	transformer isolated

Appendix B — Declaration of Conformity

Applied Council Directives:

Low Voltage Directive 2006/95/EC
General Product Safety Directive 2001/95/EC
Electromagnetic Compatibility Directive, 2004/108/EC
Restriction of Hazardous Substances Directive 2002/95/EC
Waste Electrical and Electronic Equipment Directive 2002/96/EC

Standards to which Conformity is Declared

EN 55022:2006 + A1:2007, Class A, Limits and Methods of Measurement of Radio Disturbance Characteristics of Information Technology Equipment

EN 55024:1998 + A1:2001 + A2:2003, Information Technology Equipment — Immunity Characteristics — Limits and Methods of Measurement

Manufacturer:

Contemporary Control Systems, Inc.
2431 Curtiss Street
Downers Grove, IL 60515 USA

Authorized Representative:

Contemporary Controls Ltd
Sovereign Court Two
University of Warwick Science Park
Sir William Lyons Road
Coventry CV4 7EZ
UNITED KINGDOM

Type of Equipment:

Industrial local area network repeater, link or hub

Model	Directive
	EMC
AI2-CXB	Yes
AI2-TB5	Yes
AI2-485	Yes
AI2-485X	Yes
AI2-CXS/FOG-ST	Yes
AI2-TPB/FOG-ST	Yes
AI2-485/FOG-ST	Yes
AI2-485X/FOG-ST	Yes
AI3-CXS	Yes
AI3-TB5	Yes
AI3-485	Yes
AI3-485X	Yes
AI3-485/FOG-ST	Yes
AI3-485X/FOG-ST	Yes
AI3-FOG-ST/TB5	Yes
AI3-FOG-ST/CXB	Yes
AI3-FOG-ST/485	Yes
AI3-FOG-ST/485X	Yes

Manufacturer's Declaration: The specified products conform to the directives and standards listed above.

April 2010

