

PCM20H

ARCNET® Network Interface Modules for PC Card Computers

INSTALLATION GUIDE

INTRODUCTION

The PCM20H series of ARCNET network interface modules (NIMs) links PC Card compatible computers with the ARCNET local area network thereby providing ARCNET connectivity to laptop and notebook style computers.

The PCM20H conforms to release 2.1 of the [PC Card standard](#) Type II (5.0 mm thick) cards. The ARCNET transceiver circuitry is located in a detachable MAU (medium access unit) which plugs into the PCM20H adapter. MAUs exist for various cabling media such as coaxial cable and twisted-pair cable and are all interchangeable with one another. A 15-pin connector with a short cable attaches the MAU to the adapter.

The PCM20H incorporates the [COM20022](#) ARCNET controller with enhanced features over earlier generation ARCNET chips. New features include command chaining, sequential access to internal RAM, duplicate node ID detection and variable data rates. Data rates from 156 kbps to 10 Mbps are possible.

There are several versions of the PCM20H, each of which is designated by a particular transceiver. The PCM20H-CXB can support either coaxial star or bus networks. The PCM20H-TB5 and PCM20H-TPB support twisted-pair bus with either RJ-45 or RJ-11 connectors. The PCM20H-485D supports non-backplane mode DC EIA-485. The PCM20H-485X supports non-backplane mode AC EIA-485. The PCM20H-485 supports backplane mode DC EIA-485 while the PCM20H-485T supports backplane mode AC EIA-485.

The PCM20H is shipped with a 3.5" (9cm) disk containing our DOS, Windows 3.x, and Windows 95, 98 enabler software. Once loaded, programs written for the PCX20 will transparently operate with the PCM20H.

The PCM20H is primarily intended for industrial applications. Although functionally equivalent to its predecessors the PCM20 and PCM20E, the PCM20H has improved EMC performance, ruggedized MAU case and locking MAU connector. The PCM20, PCM20E and PCM20H are all software compatible.

SPECIFICATIONS

Environmental

Operating temperature: 0°C to +55°C

Storage temperature: -20°C to +65°C

Data Rates

PCM20H* 10 Mbps, 5 Mbps, 2.5 Mbps, 1.25 Mbps, 625 kbps,
312.5 kbps, 156.25 kbps

- * The -CXB, -TB5, and TPB models can only operate at 2.5 Mbps. The -485X and -485T models can only operate at 1.25, 2.5, 5.0 or 10 Mbps.

Dimensions

Type II adapter: 3.370"L x 2.126"W x 0.196"T
(85mm x 54mm x 5mm)

MAU: 3.175"L x 1.835"W x 1.005"T
(81mm x 46mm x 26mm)

Cable

11.125" (28.3cm) Approx. MAU base to adapter base

Shipping Weight

1 lb. (.45kg)

I/O Mapping

Supports I/O mapping on any 16-byte boundary

Interrupt Lines

Supports IRQ2 through 15

Compatibility

PCM20H series NIMs are compliant with ANSI/ATA 878.1 and [PC Card Standard](#) Feb. 1995.

Power Requirements

Model	+5V
PCM20H-CXB	120mA
PCM20H-TB5	120mA
PCM20H-TPB	120mA
PCM20H-485	100mA
PCM20H-485D	100mA
PCM20H-485X	100mA
PCM20H-485T	100mA

INSTALLATION

The PCM20H conforms to release 2.1 of the [PC Card standard](#) Type II (5.0 mm thick) cards. Consult your laptop or notebook user manual for instructions on how to install the adapter card. Attached via a 15-conductor cable to the adapter card is a medium access unit. Field connections are made to the medium access unit.

DOS and Windows 3.1X Instructions

One of the design goals for the PCM20H PC Card ARCNET Adapter was to use existing drivers without requiring software modifications to those drivers. PCM20.EXE is a terminate-and-stay-resident (TSR) software utility that configures the PC Card socket to match the requirements of the driver software. PCM20.EXE must be executed before the driver attempts to access the PCM20H PC Card ARCNET Adapter.

The command line for the PCM20.EXE utility is as follows:

```
pcm20 -p<port adr> -i<enable> -l<interrupt level> -n<node id> -e -h
```

where

- p<port address> sets the base address of the adapter
16 sequential addresses are used
- i<enable> enables the interrupt if <enable> is '1'
disables the interrupt if <enable> is '0'
- l<interrupt level> sets the IRQ number for the interrupts
- n<node id> sets the node address in hexadecimal that is
stored on the PCM20H PC Card ARCNET
Adapter to simulate the DIP switch setting
- e enables extended error reporting. This will cause the Card
Services vendor and version to be displayed. Additional
information about certain errors will also be displayed.
- h displays the syntax of the PCM20.EXE command line

There are defaults built into the PCM20.EXE software. These defaults are as follows:

port address:	300h
interrupts:	disabled
IRQ level:	IRQ5
Node ID:	0FFh

The Card Services software, which manages the PC Card socket, will check the resources installed in your computer and will complain if you attempt to request a resource that is already in use. For example, if you have COM4 in your computer, the default base address is

2E8h. If you request a base address of 2E0h for the PCM20H PC Card ARCNET Adapter, Card Services will reject your request because of the overlap occurring between 2E8h to 2EFh. If this occurs, you will either have to select a different address for the PCM20H PC Card ARCNET Adapter, or remove the COM4 hardware from your computer. Similar conflicts could also occur with the requested interrupt levels.

If a conflict does occur, PCM20.EXE reports the problem and then exits without remaining resident. If PCM20.EXE successfully configures the PC Card socket, then it will remain resident. Once it is resident, executing it again will report that it is already resident and will exit leaving the resident version still in memory. The only way to remove the resident version is to reboot the computer.

PCM20.EXE is intended for use with MS-DOS version 5.0 and above. When resident, PCM20.EXE uses about 18K bytes of RAM in the lower address space.

Base Port Address

When setting the port address, PCM20.EXE assumes that the right most nibble of the base port address is 0. Therefore, use base addresses such as 300h, 310h and so on.

Node ID Switch Emulation

If the node ID switch logic is supported by the application software, enter the desired node ID (non-zero value) in the command line. A zero will prevent the adapter from joining the network. Remember that the node ID switch is simply a register that may or may not be read by the application software. It does not directly set the adapter node ID address. The application software must do that.

Instructions for Windows 95/98/ME

Upon plugging the PCM20H into the PC Card slot you will be prompted for a disk from the manufacturer. Use the provided disk and once installed your PCM20H will appear to the system as a standard ISA COM20020 based ARCNET card. If you want to use this card for Windows NDIS based networking, do NOT load this disk. Go to our web site at <http://www.ccontrols.com> and retrieve the appropriate PCM20 NDIS driver. Then create a new disk using the files from our site and provide this to Windows when prompted for a "disk from the manufacturer."

Under Windows 95, after you load the PCM20 enabler, you will be able to adjust your PCM20H's I/O base address. Under Windows 98, however, the assigned I/O base address is not adjustable. If your driver or application needs to have the PCM20H in the lower portion of I/O space (100-3FF), a special Windows 98 enabler is available from our web site which will place the PCM20H between 240 and 3F0 (hex).

PCM20H Enabler for Windows 95/98/ME—Loading Instructions:

1. Plug in your PCM20H PC Card.
2. If the “New Hardware Found” dialog is shown, select the “Driver from a disk provided by hardware manufacturer” option, insert this disk and press “OK.” If the “Update Device Driver Wizard” dialog is shown, then insert this disk and follow the instructions provided by Windows.
3. Provide the system with the location of this floppy drive when prompted (e.g. “a:\”). Some versions of Windows 95/ 98/ME may report that the file pcm20.vxd cannot be found. If this occurs, enter the location of this floppy disk in the box provided (e.g. “a:\”).
4. The driver should now be loaded. Reboot the machine if requested by Windows.
5. Now proceed to the Windows Control Panel. Double click the System icon. Choose the Device Manager tab. Select the “View devices by type” option.
6. The PCM20 should be listed as a generic category symbolized by a gray diamond. It will not be listed under the network adapters category. Double click this category and you should see a PCM20 device listed. Double click this device.
7. Now choose the resources tab. Deselect the “Use automatic settings” box. You can now modify your PCM20H’s resource settings (I/O range and Interrupt Request). After modifying these parameters press “OK.” You may then be prompted with a warning, press “Yes” to continue.
8. Your PCM20H should now be accessible at the I/O and Interrupt settings you selected in step 7.
9. You may also need to run the Setnode.exe program (located on this disk) to set your node ID (see readme.txt). Some application programs require the node ID to be set before they can operate correctly.

Software Utilities

The disk shipped with the PCM20H contains the files to enable the PCM20H under DOS, Windows 3.x and Windows 95/98/ME. If you are running DOS or Windows 3.x, please read the readme.dos file. If you are running Windows 95/98/ME, please read the readme95.wri file.

This disk also contains several DOS utilities which can be used after your PCM20H has been properly enabled.

IRQTEST.EXE: This program will allow you to test your I/O and interrupt settings. This program requires two parameters. The first

Passive hubs should not be used with -CXB NIMs and only the use of RG-62/u coaxial cable is recommended for segments. Contemporary Controls (CC) also supplies BNC terminators and Tee connectors. Ask for BNC-TER and BNC-T respectively. One note of caution, there is a minimum cable length between nodes (6 feet /2 meters). Do not violate this specification since unreliable operation may result.

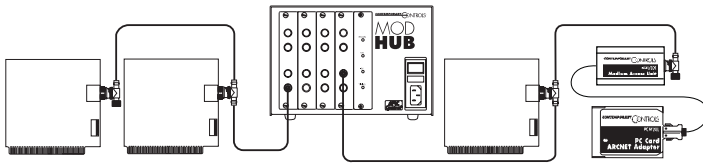

Figure 2—Bus segments can be extended through active hubs.

If star operation is required of the PCM20H instead of bus, simply connect a BNC-TER and BNC-T to the end of the coaxial cable and then attach the combination to the MAU. These accessories are included with the product. This arrangement effectively converts the -CXB transceiver into a -CXS compatible node.

-TB5, -TPB Twisted-Pair Bus

The -CXB transceiver can be modified to drive a balanced cable system with the addition of some components. This configuration is called -TB5 and it supports shielded or unshielded twisted-pair cable such as IBM type 3. Dual RJ-45 connectors replace the single BNC connector in order to support the popular modular plug connectors. Included with the product is a TB5-TER which is a 100 ohm, RJ-45 style terminator. The -TPB configuration is identical to the -TB5 except that dual RJ-11 connectors are used and a TPB-TER is supplied for termination. Wiring between NIMs is accomplished in a daisy-chain fashion with point-to-point cables connecting the various NIMs to create a bus segment. The end NIMs will have one vacant RJ-45 socket which is to hold the RJ-45 style 100 ohm terminator required to terminate the end points of the bus segment. Use twisted-pair cable and observe polarity. Modular plugs must be installed on this cable such that they do not invert the signals. Most satin cable does not twist the pairs nor maintain signal polarity. Do not use this cable. To test for the proper cable connections, hold both ends of the cable side by side with the retaining clips facing the same direction. The color of the wire in the right-most position of each plug must be the same if there is no inversion of the cable. If this is not the case, the cable is inverted. Up to eight -TB5 or -TPB NIMs can be connected to one segment which cannot exceed 400 feet in length.

The overall distance of a twisted-pair network can be expanded beyond 400 feet if active hubs are used. Use a hub port that supports a balanced twisted-pair signal (-TPS) or use a BALUN. CC recommends a Mux Labs BALUN

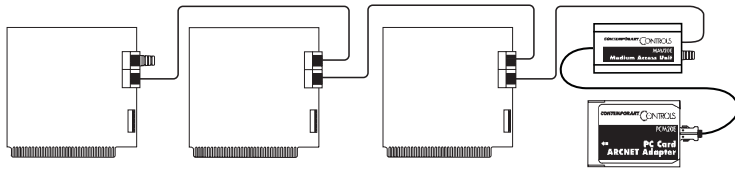

Figure 3—TB5 NIMs are connected in a daisy-chain fashion with terminators inserted at both end NIMs.

(available from CC under the part number BALUN) connected to a -CXS port on a MOD HUB expansion module. The BALUN converts the balanced twisted-pair signals to single-ended signals suitable to the -CXS port. A more direct approach is to use a MOD HUB expansion module with a -TPS port. The -TPS port has an internal BALUN and provides an RJ-11 connection. The signal sense is inverted from the -TB5 and -TPB modules so that an inverted cable connection is required to either the BALUN or -TB5 (-TPB) port.

-485D DC Coupled EIA-485

The PCM20H-485D supports DC coupled EIA-485 communication via a transceiver which replaces the coaxial hybrid transceiver in the MAU. This transceiver receives the conventional P1 and P2 pulses intended for the coaxial hybrid transceiver and converts them to an elongated P1 pulse (the width is equal to P1 and P2) suitable for the EIA-485 differential driver. Therefore, do not set the controller chip to backplane mode for EIA-485 communication as recommended in Standard Microsystems Corporation's (SMSC) application note and data sheet since CC implements the same signaling via circuitry. With our approach, the same software driver used for coaxial networks will function with this EIA-485 version of the PCM20H without modification.

Use the three position screw connector for connecting multiple nodes onto one segment. This segment can be up to 900 feet long of IBM type 3 unshielded twisted-pair cable and as many as 17 nodes can occupy the segment. Make sure that the phase integrity of the wiring remains intact. Pin 1 of the screw connector on each NIM or MAU must be connected together. The same applies to pin 2.

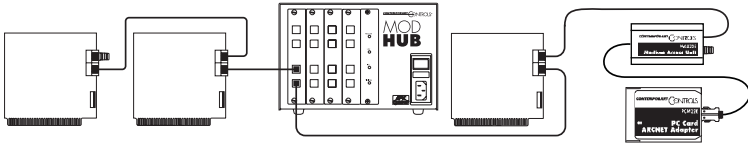

Figure 4—TB5 bus segments can be extended through active hubs.

Termination

Each end of the segment must be terminated in the characteristic impedance of the cable. If it is desired to apply termination, connect a 100 ohm ¼ watt resistor across pins 1 and 2.

Bias

In addition to the termination, it is also necessary to apply bias to the twisted-pair network so that when the line is floated differential receivers will not assume an invalid logic state. Bias is not provided by the MAU. It is assumed that sufficient bias is provided by the existing EIA-485 NIMS. Refer to the appropriate NIM user manual for a more in depth discussion on bias requirements.

For EIA-485 DC operation, it is very important that all devices on the wiring segment be referenced to the same ground potential in order that the common mode voltage requirement (+/-7 Vdc) of the EIA-485 specification is achieved. This can be accomplished by running a separate ground wire between all computers or by relying upon the third wire ground of the power connector assuming that the DC power return is connected to chassis ground on the computer. Another approach

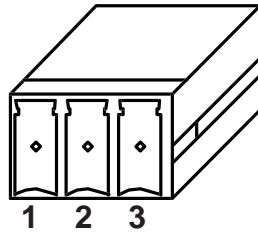

Figure 5—Screw Terminal Connector Numbering Orientation

PIN	TRANSCIVER		
	-485	-485D	-485X
1	LINE+	LINE+	LINE
2	LINE-	LINE-	LINE
3	SHIELD	SHIELD	SHIELD

Table 1—Screw Terminal Connector Pin Assignments for -485, -485D and -485X

would be to connect the DC common of each computer to a cold water pipe. Connected systems, each with different elevated grounds, can cause unreliable communications or damage to the EIA-485 differential drivers.

Therefore, it is important that an adequate grounding method be implemented. Pin 3 on the screw

connector can be used for the common ground connection.

Segments of -485D connected NIMs or MAUs can be extended through the use of active hubs. Select a MOD HUB expansion module with a -485 compatible port. Connect one end of the segment to this port following the same termination rules as used for a NIM. This hub port counts as one NIM when cable loading is being calculated. The NIM electrically closest to the

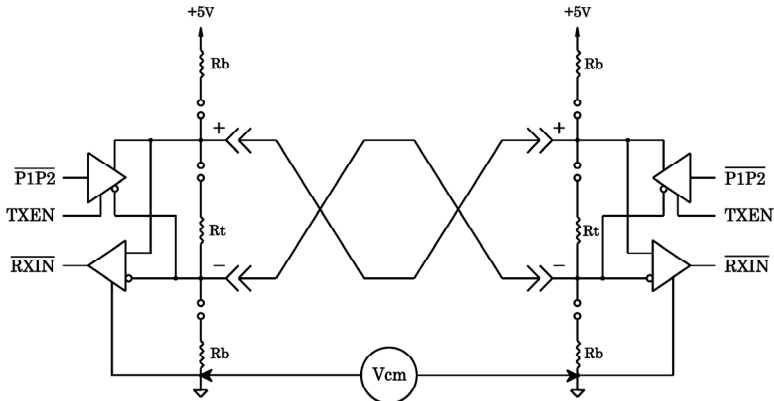

Figure 6—Make sure common mode voltage (V_{cm}) does not exceed ± 7 Vdc for -485 and -485D MAUs.

hub port should not have any termination applied. Follow the same rules for other segments attached to different hub ports. Each hub effectively extends the segment another 900 feet (275 meters). Maintain the same cabling polarity as the NIMs by using cable connections that do not invert the signals.

-485 DC Coupled EIA-485 (Backplane Mode)

If it is desired to utilize software that puts the ARCNET controller chip into backplane mode, then it is necessary to use the MAU20H-485. The rules for using the MAU20H-485 are the same for using the MAU20H-485D. The only difference is that the MAU20H-485 requires backplane mode on the controller chip, while the MAU20H-485D cannot be used in backplane mode.

485X AC Coupled EIA-485

The AC coupled EIA-485 transceiver offers advantages over the DC coupled EIA-485 (-485D). No bias adjustments need to be made since each transceiver has its own fixed bias network isolated by a pulse transformer. Unlike

Modular Connector Pin Assignments	
8-Contacts	
Pin	Usage
1	Not Used
2	Not Used
3	Not Used
4	Line- (Phase B)
5	Line+ (Phase A)
6	Not Used
7	Not Used
8	Not Used

Table 2—Modular Connector Pin Assignments for -TB5

the DC coupled EIA-485, wiring polarity is unimportant. Either inverted or straight through cable can be used or even mixed within one AC coupled

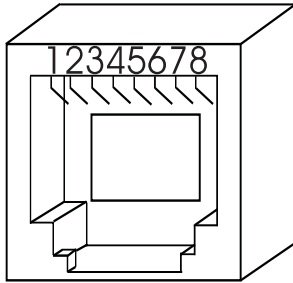

Figure 7—Modular Jack Numbering Orientation for -TB5

network. Much higher common mode voltage levels can be achieved with AC coupling due to the transformer coupling which has a 1000 Vdc breakdown rating.

There are disadvantages to the AC coupled transceiver as compared to the DC coupled technology. The DC coupled distances are longer (900 feet/275m) compared to the AC coupled distance (700 feet/213m). The AC coupled transceiver is optimized for 2.5 Mbps while the DC coupled transceiver will operate over all six baud rates.

The cabling rules of the -485X are similar to the -485D and -485. A three position screw connector is used with each MAU. Wire a maximum of 13 NIMs to any one segment. Apply termination to the end NIMs. Do not mix -485D and -485X NIMs together on one segment; however, bridging of the technologies is possible using active hubs with the appropriate transceivers. To extend -485X segments, use a hub as discussed under the -485D section. Make sure that the active hub transceivers are of the -485X type. Cable inversion is not of any consequence.

-485T AC Coupled EIA-485 (Optional)

There is a special MAU available that supports the Toyo Microsystems Corporation (TMC)

Wiring Chart RJ-11 Connector		
PIN	-TPB	-485T
1	-	-
2	N/C	N/C
3	LINE-	LINE
4	LINE+	LINE
5	N/C	N/C
6	-	-

Table 3—Modular Connector Pin Assignments for -TPB and -485T

HYC4000 transceiver. The MAU20H-485T incorporates TMC's HYC4000 transceiver which requires that the ARCNET controller chip be programmed for backplane mode. The rules for using the MAU20H-485T are the same for using the MAU20H-485X. Connections to this MAU are made using dual RJ-11 connectors.

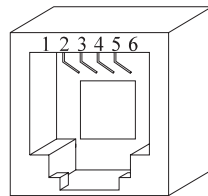

Figure 8 Modular Jack Number Orientation for -TPB and -485T

NEED MORE HELP INSTALLING THIS PRODUCT?

More comprehensive information can be found on our web site at www.ccontrols.com. Browse the Technical Support section of our site for a look at our interactive on-line technical manuals, downloadable software drivers and utility programs that can test the product. When contacting one of our offices, just ask for Technical Support.

Warranty

Contemporary Controls (CC) warrants its product to the original purchaser for one year from the product's shipping date. If a CC product fails to operate in compliance with its specification during this period, CC will, at its option, repair or replace the product at no charge. The customer is, however, responsible for shipping the product; CC assumes no responsibility for the product until it is received. This warranty does not cover repair of products that have been damaged by abuse, accident, disaster, misuse or incorrect installation.

CC's limited warranty covers products only as delivered. User modification may void the warranty if the product is damaged during installation of the modifications, in which case this warranty does not cover repair or replacement.

This warranty in no way warrants suitability of the product for any specific application.

More warranty information can be found on our web site www.ccontrols.com.

Returning Products for Repair

Before returning a product for repair, contact Customer Service. A representative will instruct you on our returns procedure.

Contemporary Control Systems, Inc.
2431 Curtiss Street
Downers Grove, Illinois 60515 USA
Tel: +1-630-963-7070
Fax: +1-630-963-0109
E-mail: info@ccontrols.com
WWW: <http://www.ccontrols.com>

Contemporary Controls Ltd
Sovereign Court Two
University of Warwick Science Park
Sir William Lyons Road
Coventry CV4 7EZ UK
Tel: +44 (0)24 7641 3786
Fax: +44 (0)24 7641 3923
E-mail: ccl.info@ccontrols.com